



NOVOTEST

QUALITY TESTING DEVICES



**HARDNESS
Testing**

**ULTRASONIC
Testing**

**COATING
Testing**

**CONSTRUCTION
Materials Testing**

**MAGNETIC
Testing**

CATALOGUE

NOVOTEST is manufacturer of devices and systems for non-destructive testing.
 Today we design and produce instruments for measuring a wide range of parameters and quality testing of the majority of products: hardness testers, ultrasonic flaw detectors and thickness gauges, coating testing instruments, devices for quality testing of construction materials, magnetometers, gauges for environmental control and many others.

HARDNESS TESTING

- Portable Hardness Testers
- Bench Hardness Testers
- Hardness Test Blocks
- Shore Hardness Testers

- p. 4-13

ULTRASONIC TESTING

- Ultrasonic Flaw Detectors
- Transducers (UT-Probes)
- Ultrasonic Thickness Gauges
- Calibration and Reference Blocks

- p. 14-21

COATING TESTING

- Adhesion Testing Instruments
- Viscosity Meters
- Devices for testing of Coatings on Metals
- Instruments for Strength Testing
- Environment Testing Devices

- p. 22-35

CONSTRUCTION MATERIALS TESTING

- Rebar Detector
- Concrete Test Devices

- p. 36-37

MAGNETIC TESTING

- Steel Structure Analyzer
- Gaussmeter
- Instruments for MPI and PT

- p. 38-39

- More than 10 years on NDT market;
- Leading manufacturer of NDT devices in Ukraine;
- Representative offices in more than 30 countries around the world;

- Powerful development centre;
- Constant expansion of the product range;
- Manufacturing customized NDT systems;
- Solutions for non-standard NDT tasks;
- After-sales service and technical support;
- Individual approach for cooperation with dealers.

HARDNESS Testing

Combined Hardness Tester NOVOTEST T-UD3



Unique device – the world's first hardness tester with photo-fixing of measurements which allows to bind the values of hardness to tested objects with indication of a specific place on the product!

Hardness tester works as with the UCI so with the dynamic (Leeb) probes. User can get the advantages of the two methods of measurement – these are the maximum possibilities, which can be obtained from a portable device.

The device comes preconfigured for measuring the hardness of a wide range of materials – steel, alloyed steels, stainless steels, non-ferrous metals (aluminum, bronze, brass, copper, iron).



Leeb Probe ASTM A956

UCI Probe ASTM A1038



Sealed housing with rubber protecting shockproof linings makes the device perfectly suitable for work in the workshop and field conditions with high humidity, dust, etc.

The hardness tester has a frost-resistant display that allows user to use the device at any time of the year in any climatic zone of the Earth.



The built-in camera allows making photographs of the testing object with subsequent imposition of the measured values of hardness on it in a real time. It implements the most reliable and clear method of logging of measurements.



The device comes with special software to work on the PC with the archive of measurements.



Several modes of displaying information are implemented in the hardness tester, these modes substantially increase the usability of the device and designed for maximum reliable measurement of hardness:

- Graph – the mode of building the graph;
- Histogram – the mode of building the histogram;
- Statistic – the mode of statistics;
- Smart – the mode of filtering incorrect measurements;
- Signal – the mode of displaying the signal (only for Leeb probe).

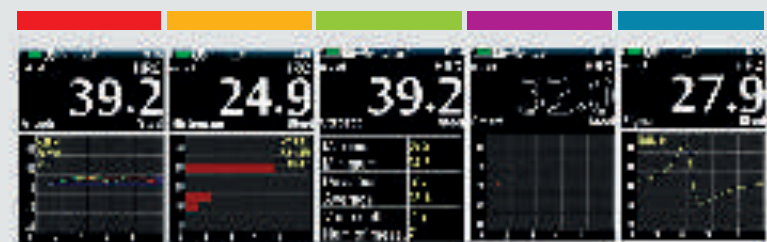

Standard set includes all necessary items for operation with hardness tester.



Hardness testers NOVOTEST are supplied in shockproof protective cases.

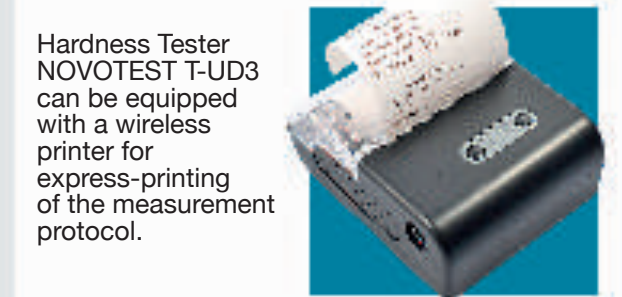

Hardness Tester NOVOTEST T-UD3 can be equipped with a wireless printer for express-printing of the measurement protocol.

HARDNESS Testing



UCI Hardness Tester NOVOTEST T-U3

Ultrasonic contact-impedance (UCI) probe is used for measurement of hardness of small products, objects with a thin wall, complex shapes with thickness from 1 mm and weight over 0,1 kg, for measuring the hardness of hardened layer's surface.

UCI Hardness Tester NOVOTEST T-U3 uses ultrasonic contact-impedance method of measuring hardness standardized according to **ASTM A1038**.

The method allows making measurements very fast and easy: install the probe, load the spring for indentation the indenter with necessary load, read the hardness value on the device's display.



There are available UCI probes with different loads: 10N, 50N, 98N for hardness testing of different surface finish products.

The using of diamond indenter allows setting the probe precisely in any tiny point. The depth of the imprint left by Hardness tester T-U3 is many times smaller than imprint left by standard Rockwell hardness tester, which makes this method of measuring the least destructive.

These advantages make Hardness tester T-U3 perfectly suitable for solving the following tasks: hardness measurements of products with complicated shape, fine-grained materials, heat-treated materials, thin layers and coatings, parts with surface hardening, thin-walled pipes, the small details, etc.



Leeb Hardness Tester NOVOTEST T-D3

Dynamic Leeb probe is used for measuring the hardness of steels, non-ferrous metals, cast iron, materials with coarse-grained structure, solid products.

Hardness tester NOVOTEST T-D3 uses dynamic method of hardness measurement – Leeb method, standardized according to **ASTM A956**.

The method allows fast measurement of hardness: it is necessary to set the probe on the surface of the testing object, press the release button, read the hardness value of the device's display.

The method allows measurement of hardness of coarse materials (stainless steel, cast iron, etc.), products with ill-prepared surface, massive products – this method is perfectly complements the ultrasonic method for measuring hardness.



Standard set of Hardness tester includes D type Leeb probe, but it also can be equipped with DC, DL, D+15, C, G, E type probes.

NOVOTEST T-D3 makes automatic calculation of hardness for a wide range of materials - steel, stainless steels, cast iron, bronze, aluminum, which allows calling this hardness tester one of the most universal.

HARDNESS Testing



Combined Hardness Tester NOVOTEST T-UD2

Combined hardness tester of metals NOVOTEST T-UD2 is a multipurpose device of rapid non-destructive testing.

Hardness tester NOVOTEST T-UD2 is ideal for solving the following tasks:

- Testing of hardness of ferrous and non-ferrous metals;
- Testing of hardness of cast iron and various alloys;
- Determining the tensile strength of carbon steel products from pearlite class.

UCI Probe
ASTM A1038

Leeb Probe
ASTM A956



Shore Durometer NOVOTEST TS-A (analog)



Shore Durometer NOVOTEST TS-C (digital)

Shore Durometer NOVOTEST standardized according to **ISO-7619** and **ISO-868**, **DIN53505**, **ASTM D2240** and **JIS K7215**.

Typical testing objects of Shore Durometer are: soft plastic, printed circuit boards, glass, elastomers, fibers, soft rubber, leather, resin, wax, butyl, silicone, vinyl.



Shore Hardness Test Blocks NOVOTEST

Shore A and Shore D blocks according to **ISO 7619-1-2009** and **ISO 868-85**



UCI Hardness Tester NOVOTEST T-U2



Hardness tester NOVOTEST T-U2 uses ultrasonic contact-impedance method of measuring hardness standardized according to **ASTM A1038**.

UCI probe is used for measuring the hardness of small products, objects with a thin wall, complex shape, to measure the hardness of surface hardened layers.

UCI Probe Test Stand NOVOTEST

It is the accessory unit for portable NOVOTEST hardness testers (T-U2, T-U3, T-UD2, T-UD3), which is specially designed for UCI probe.



UCI Probe Test Stand NOVOTEST is used for fixation of small, thin products (even less 1 mm) during tests. It makes testing more accurate and more convenient for users.

Leeb Hardness Tester NOVOTEST T-D2

Hardness tester NOVOTEST T-D2 uses dynamic method of hardness measurement – Leeb method, standardized according to **ASTM A956**.

Dynamic Leeb probe is used for measuring the hardness of non-ferrous metals, cast iron, materials with coarse-grained structure, solid products.



Hardness Test Blocks NOVOTEST



Hardness test blocks Rockwell (HRA, HRB, HRC), Brinell (HB), Vickers (HV) and Leeb (HLD, HLG) are designed for checking measurement accuracy and calibration of bench or portable hardness testers of metals.



HARDNESS Testing



Analog Rockwell Hardness Tester NOVOTEST TB-R

Rockwell Hardness Tester NOVOTEST TB-R is designed in accordance to **ISO 6508-2, ASTM E18** for hardness testing of products made of various kinds of steels, such as cast iron, tempered cast iron, all sorts of alloys and other kinds of metals. Also it is used for manufacturing of Rockwell calibration test blocks for portable hardness testers.

**MOST
COMMONLY
USED**



NOVOTEST TB-R implements direct Rockwell method of hardness testing, which is based on the testing of samples for resistance to penetration of indenter with certain load – the most commonly used hardness test method.

The hardness tester is equipped with large and small flat tables, and V-shape anvil which are used for testing of objects with different shapes.

NOVOTEST TB-R is reliable machine, and also very easy in operation and servicing. It works without power supply.

Features:

- Operation without microscope;
- Simple and reliable tester, very easy in operation;
- Works without power supply.



Digital Brinell Hardness Tester NOVOTEST TB-B-C

Digital Brinell Hardness Tester NOVOTEST TB-B-C Brinell hardness tester is reliable and easy in operation, is used for hardness testing of big grain metal products (casted parts, non-ferrous metals and alloys), various tempered and hardened steels, samples from soft metals (pure aluminum, lead, tin) and others, according to **ISO 6506-2, ASTM E10**.



It also can be used for production of Brinell hardness test blocks.

The machine has tungsten carbide ball indenter, using heavy testing force (large indentation), it provides highly accurate and repeatable measurement results.

Features:

- Automatic loading and unloading;
- 10 testing loads and scales;
- Includes small, large flat and V-shape tables;
- Can be equipped with external analog microscope or automatic camera measuring system with PC software for analysis of the imprints.



HARDNESS Testing



Digital Micro Vickers Hardness Tester NOVOTEST TB-MCV-1A

NOVOTEST TC-MCV-1A is designed according to **ISO6507-2**, **ASTM E384** for hardness testing of carburized and nitride layers, surface hardened layers, hardness of the coatings; ceramic, steel, non-ferrous metal products; sheets, metal foils, platings, small and thin objects (from 25µm). The hardness tester has a built-in microscope for measuring diagonals of imprints and automatically calculates hardness values into different micro Vickers scales.

HIGH PRECISION MACHINE



The machine allows user to maximize the efficiency of the using portable hardness testers, especially UCI hardness testers, because TC-MCV-1A implements direct method of hardness measuring.

Features:

- Vickers and Knoop indenters;
- Automatic hardness calculation;
- Large contrast LCD display;
- Automatic loading, dwell unloading
- 10x and 40x microscope;
- Movable table;
- Can be equipped with automatic measuring system and PC software.

Analog Brinell, Rockwell, Vickers Hardness Tester NOVOTEST TB-BRV



Brinell, Rockwell, Vickers Hardness Tester is designed to **ISO 6508**, **ASTM E 10**, **ASTM E92**, **ASTM E18**, **ASTM E384**, **ASTM E103** for hardness testing of ferrous (steel, cast iron, low carbon steel and tempered steel, etc) and non-ferrous metals (aluminum, copper, etc), hard alloys, carbonized and chemically treated layers.

UNIVERSAL HARDNESS TESTER



The hardness tester implements Rockwell, Brinell and Vickers hardness testing methods, which makes it a universal and multi-functional machine.

NOVOTEST TB-BRV has an electric actuator – the main test load is completely automated. The instrument also allows maximize efficiency of using portable hardness testers. Using this device user can check or produce standard hardness test blocks to calibrate portable hardness testers according to any of the most popular hardness scales (HRC, HB, HV).

Features:

- Rockwell, Brinell, Vickers methods;
- Suitable for any metals;
- 37.5X and 75X microscope;
- Includes small, large flat, V-shape and movable tables.



ULTRASONIC Testing



Ultrasonic Flaw Detector NOVOTEST UD3701

Ultrasonic Flaw Detector NOVOTEST UD3701 is designed for non-destructive testing of quality of metals, plastics, glass, composite materials, weld inspection and measuring the thickness of various products and constructions.



UT-probes



Flaw detectors can be equipped with various ultrasonic and electromagnetic acoustic transducers.

Flaw detector enables to detect defects such as discontinuities and heterogeneity of materials in semi-finished products, finished products and welded joints, measure the depth and the coordinates of defects depth, measure the thickness of the products, measure the velocity of propagation and attenuation of ultrasonic fluctuations in the material.

Ultrasonic Flaw Detector NOVOTEST UD3701 allows not only to carry out the testing for presence of internal defects, but also to measure the thickness of products with high accuracy.



Ultrasonic Flaw Detector NOVOTEST UD2301



In contrast to standard type UD3701, Ultrasonic Flaw Detector NOVOTEST UD2301 is made in miniature housing, optimal in size for performing testing in tight spaces and operation in the field. At the same time flaw detector equipped with a clear color display with high resolution 480x320 pixels, which significantly improves the usability of the device.

The flaw detector display can operate in any orientation – all 4 options, display rotation by 90 degrees allows user to configure the device at the left-handed and right-handed, the display can be used in portrait and landscape orientation.

Ultrasonic Flaw Detector NOVOTEST UD2301 with color display and miniature dimensions is the best choice for expert ultrasonic testing.

NOVOTEST UD2301 user interface

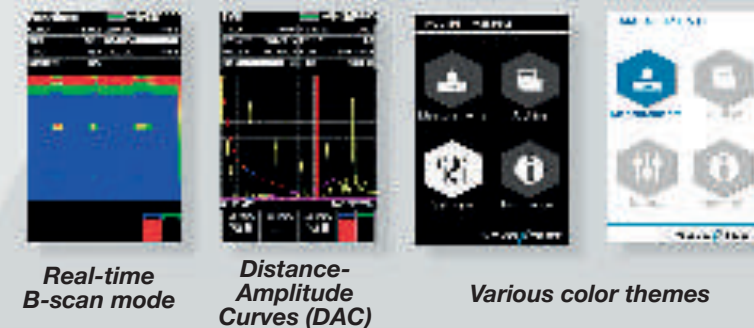

Powerful, lightweight and portable flaw detector in ergonomic shockproof housing with protective rubber treads – contemporary industrial design of flaw detector for general purposes. Device has such functions as: AFS, TVG, DAC, DGS, A-scan, B-scan, etc.

The flaw detector allows user to solve a wide range of tasks – from thickness measurements of thin products, to large-sized casting flaw detection.

ULTRASONIC Testing

NEW
PHASED ARRAY SYSTEM



Phased Array Flaw Detector NOVOTEST UD4701PA



Ultrasonic Phased Array Flaw Detector is designed for testing of metal and composite products, pipeline welds, forgings and castings, aircraft objects, corrosion inspection, etc. in accordance to **EN 12668-1**, **ISO 18563-1**.

NOVOTEST UD4701PA can be used both with standard 1 channel transducers and PA 16 channel probes. Using SAFT method the device allows to get high resolution and quality image of scanning. Using replaceable prisms, allows to avoid wear of the transducers and inspect any curved surfaces.

Based on innovation technologies, the device has light weight (1,5 kg) and includes such functions, as A, B, C, D, S, L-scan, TOFD, DAC, DGS, AFS, AWS modes, automatic calibration of ultrasonic velocity, reconstruction mode of weld joints geometry and others.

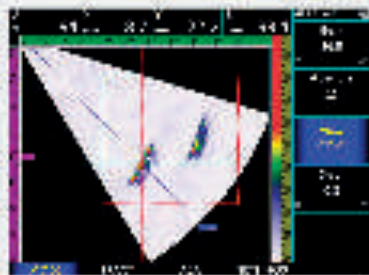

Scanning with 16 channel PA probe

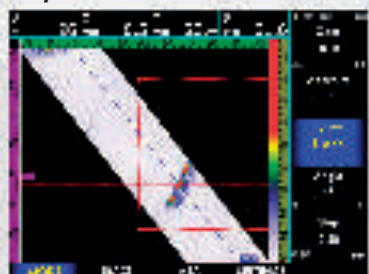

S-scan and L-scan

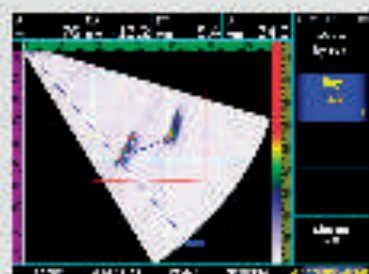

Measuring relative dimensions of the defects using marker



Ultrasonic Calibration Blocks NOVOTEST



Custom made calibration blocks with notches (corner reflectors) are made of the same materials (steel, stainless steel, aluminum and others) as the tested objects, wherein the geometry (thickness and surface radius of standard sample) has the same characteristics as tested item.



Ultrasonic Reference Blocks NOVOTEST

Calibration blocks are used to configure the sensitivity and duration of scan of ultrasonic flaw detectors during testing of various products (mainly flat sheets and pipes).

We produce standard reference blocks (V1, V2, etc.) according to ISO, DIN and other standards, which are used for calibration ultrasonic flaw detectors and UT-probes. Samples are made from low carbon fine-grained steel with a small damping coefficient.

Thickness Gauge Calibration Blocks NOVOTEST



These blocks are used for checking the measurement accuracy and calibration of thickness gauges. There are available different metric versions, for example, with steps from 1mm through 10 mm, from 2 mm through 20 mm or from 10 mm through 50 mm, etc.



The blocks can be produced in accordance with different standards, such as **ASTM E-797**, etc. from steel, stainless steel, aluminum and others materials are also available.

ULTRASONIC Testing



Thickness Gauge NOVOTEST UT-3A-EMA

NOVOTEST UT-3A-EMA is designed to measure thickness of objects, such as pipes, tanks, sheet products, ship bottoms and other parts, made of metals and alloys, without application of couplant and advance surface preparation, through air gap or a layer of rust, dirt, salt or other non-conductive coatings (paint, varnish, enamel, plastic, etc.) up to 6 mm. Also it is used for evaluation of anisotropy degree of the material.



Pulsed electro - magnetic technology implemented in the EMA transducers allows user to put the probe not exact perpendicular to the surface, but up to 25 degrees of skew and get correct readings.

The device has a bright contrast LCD display, A-scan, B-scan, calibration settings, three thickness measurement modes:

- Automatic;
- Manual mode, measurements are made using maximum in the first gate;
- Manual mode, measurements are made using two maximums in two gates.



Thickness Gauge NOVOTEST UT-3K-EMA

The thickness gauge UT-3K-EMA is designed for use in industrial networks, sheet metal products, rods and other products made of steel, as well as aluminum and other metals, without using of couplant, without preliminary surface preparation, with space between the probe and metal up to 3 mm. As a gap may be a layer of rust, a layer of salt deposits or other non-conductive coating (paint, varnish, enamel, plastic).

The readings of the device are slightly affected by skew, in contrast to traditional thickness gauges with piezoelectric transducers, which require fixation of the probe in a certain position. The thickness gauge UT-3K-EMA uses a special data processing algorithm that allows the thickness to be measured correctly in the presence of disturbing factors such as metal anisotropy, the presence of several reflectors, and the presence of external interference.

The algorithm developed by our specialists allows to reduce the human factor and simplify the interface of the device.

Connecting a tablet, smartphone or other device based on Android OS allows user to expand the capabilities of the UT-3K-EMA thickness gauge to the level of a modern flaw detector, with the ability to display and save A-scan, B-scan, the ability to work with strokes, choose the thickness measurement mode, parameters signal processing, etc.



ULTRASONIC Testing



Ultrasonic Thickness Gauge NOVOTEST UT-1M

Portable Ultrasonic Thickness Gauge NOVOTEST UT-1M is designed for rapid non-destructive testing of thickness of objects and constructions made of different materials.



It is used for testing the thickness of:

- Objects of various alloys of metals;
- Objects of non-metallic materials - composite, glass, plastic;
- Hull parts, sheets, vessel walls;
- Transportation and bridge design, including corrosion defects (scale, rust);

Advantages:

- The device has shock-proof rubber protective case;
- Can be create with any UT-probes with Lemo 00 connector on cable;
- Storage of measurement results.

Thickness Gauge NOVOTEST UT-1M-IP



Unique protection against dust and moisture, previously not available in the market. By default the device comes with a degree of dust-moisture protection IP65. The device can be supplied with reinforced protection up to IP67 (submerged in water).



Unprecedented autonomy of the device - the time of continuous operation of the thickness gauge increased to 200 hours.

Special rubber lining on the side surfaces of the casing facilitates the convenient retention of the thickness gauge in the operator's hand.

Light weight and small dimensions, in comparison with similar protected thickness gauges.



Thickness gauges can be equipped with different ultrasonic testing probes: 2,5 MHz, 5 MHz, 10 MHz and various calibration blocks.

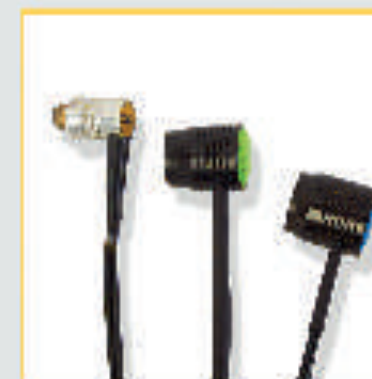

COATING Testing



Tensile Adhesion Tester NOVOTEST AC-4624

Mechanical pull-off type adhesion tester is designed for measure the adhesion value of paints and other coatings on base and between layers or cohesive materials according to **ISO 4624**, **ISO 16276-1** and **EN13144**.



Bitumen And Mastic Insulation Adhesion Tester NOVOTEST CM-4219



Adhesion tester CM-4219 is a device for measuring the adhesion value of bitumen pipe insulation and other insulating coatings which are based on bitumen.



Cross Hatch Adhesion Plate NOVOTEST AH-16276



The instrument is designed to measure the adhesion value of coatings in compliance with **ISO 16276-2** and **ASTM D 3359**.



Cross Cut Adhesion Tester NOVOTEST AN-2409



Adhesion Multiblade Knife NOVOTEST AN-2409 is designed for adhesion testing by method cuts (parallel or lattice) with thickness range of paint coatings up to 200 μ s, according to **ISO 16276-2**, **DIN 53151**, **ASTM B 335**, **ASTM D 3002**, **ISO 2409**, **NF T 30-038**, **ASTM B 3359**, **BS EN ISO 2409**, **BS 3900-E6**. Device can be used on flat and curved surfaces.



Peel Adhesion Tester NOVOTEST AP-4219



Adhesion tester AP-4219 is designed to measure the adhesive strength value of the coatings on different structures, as well as to determine the adhesion value of polymeric insulating tapes which are generally used for pipes insulation.



COATING Testing



Viscosity Flow Cup NOVOTEST VZ



Viscosity cups – testing devices that intended for measurement of rheological characteristics of liquid substances.

Viscosity flow cup – is one of the fundamental parameters measuring tool for consumables. It is used to test the viscosity of applicable liquids, as varnishes, paints, oils, liquid inks, and others.



The instruments can be produced in accordance to different standards.

Available in two models: submersible and with a tripod, which are made from aluminum or stainless steel.

Viscosity Dip Mug NOVOTEST VMS



Viscosity Dip Mug is used to determine the convectional viscosity of the dispersion polyvinylacetate homopolymer coarse dispersion.

The device is a cylindrical brass vessel with a handle and three orifices, two of them are located at the side wall of the cylinder, and the third – at the centre of the bottom.



Density Cup NOVOTEST PYCNOMETER P-2811



Density tester NOVOTEST P-2811 is designed according to **ISO 2811-1**.

The density is calculated as weight divided into volume of tested liquid.



Viscosity Flow Cup NOVOTEST VZ-P

Main standards for viscosity cups funnels are: **DIN 4 (DIN 53211-87)** and **UNE ISO DIN 2431**.

For American products there are the appropriate standards: funnel FORD (**ASTM D 120087**) and ZHAN (**ASTM D4212-93**).



Available models made from aluminium and stainless steel.



COATING Testing



Coating Thickness Gauge NOVOTEST TP-1M



Coating thickness gauge is a precision measuring instrument for rapid non-destructive testing of coatings in accordance with standard **ISO 2808**.

Coating thickness gauge is designed to test:

- Thickness of paint and other dielectrics – radioabsorbing, mastic, teflon, plastic, electroplating coatings on steel;
- Thickness of galvanic and paint coatings on non-ferromagnetic alloys and non-ferrous metals;
- Thickness of bitumen and other thick coatings on various metals and alloys;
- As well as relative humidity, air temperature, surface temperature, dew point temperature and difference between surface and dew point temperatures;
- Measuring grooves and surface roughness.



Electronic coating thickness gauge – device which widely used in shipbuilding and automotive industries for measuring of the coatings on metals, in order to test the quality of products, also it used for determining technical condition of the tested objects.



Coating Thickness Gauge NOVOTEST TP-1M can be equipped with various probes for different tasks and standard samples of various thicknesses.

User can easy connect another probe for testing of other kind of products.



COATING Testing

ALMOST FOR ANY BASES

ASTM ISO DIN

Coating Thickness Knife Tester NOVOTEST TPN-2808

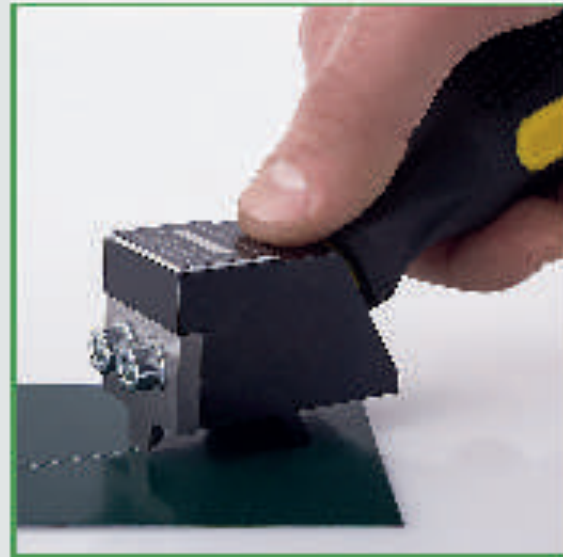

Paint inspection gauge TPN-2808 is designed according to **ISO 2808, ASTM B 4138, DIN EN 1071-2** to measure the thickness of both single and multiple layer coatings on any grounds, both metallic and non-metallic.

Analog Surface Profile Gauge NOVOTEST LIMIT

ASTM

Mechanical depth gauge is designed according to **ASTM D 4417-B, SANS 5772, US Navy NSI 009-32, US Navy PPI 63101-000.**



It is used for (depending on configuration): measures the peak-to-valley height of a blast cleaned surface; measurement the depth of focal corrosion; measures depth of narrow holes and grooves.

Pinhole Detector NOVOTEST ED-3D

ASTM



The electrolytic flaw detector (detector of porosity) NOVOTEST ED-3D is designed for rapid non-destructive testing of continuity of coating thickness up to 500 μm in accordance with standard **ASTM G62-A.**

Pinhole detector is intended for testing of porosity, not dyed places, and other violations of the continuity of protective dielectric coatings on the metal objects.

Pulse Holiday Detector NOVOTEST SPARK-1

ASTM ISO



NOVOTEST SPARK-1 is designed according to **ASTM G62-07, ISO 2746:1998 & AS3894.1-2002, ANSI/AWWAC214-07, ANSI/AWWA C213-07, ASTM D4787-08, NACE RP0274-2004, NACE RP0490-2007, NACE SP0188-2006** for testing the continuity of insulation coatings (polymer, epoxy, bitumen, etc.) of pipelines (oil, gas, etc.) and other products.

The operation principle of device is based on the fixation the breakdown of locations between the first electrode which is connected to the high-voltage source and the second electrode, which is connected to the pipe (or other testing objects).



COATING Testing

ASTM Film Applicator NOVOTEST AU-823

Film applicator AU-823 is designed for applying layers of paint and other materials with required thickness of the plate during the complex tests according to **ASTM D 823-E**.

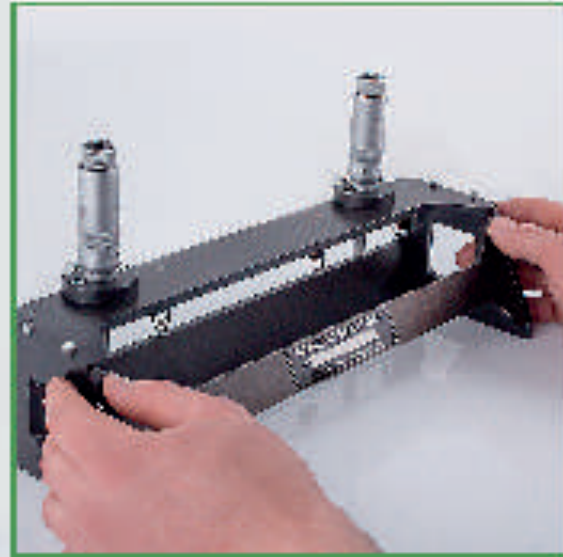
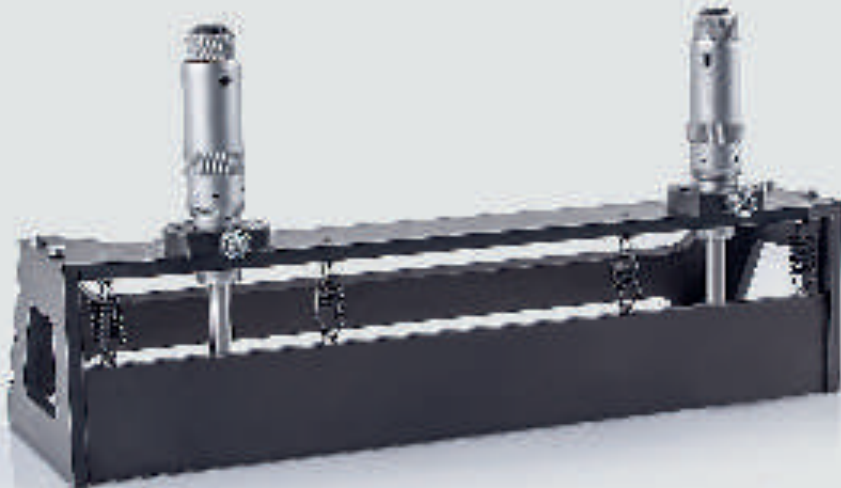

ISO ASTM DIN Grindometer NOVOTEST M-1524

The instrument is used to determine particle size and fineness of grind for different materials, such as paints, inks, coatings, chocolates and other similar products.

NOVOTEST M-1524 is designed in accordance with: **ASTM D 1210, AS/NZS 1580.204.1, DIN 53203, EN 21524, FTMS 141 4411.1, ISO 1524, JIS K 5600-2-5.**



Dew Point Meter NOVOTEST KTR-1

Dew Point Meter NOVOTEST KTR-1 is designed for rapid testing of air temperature and humidity, dew point calculation and surface temperature measurement by noncontact method.

Dew point meter measures: relative humidity, air temperature (-10 to +60°C), the surface temperature (-20 to +380°C).

And calculates: dew point, the difference between the dew point and the temperature of the surface.



ASTM ISO Pencil Hardness Tester NOVOTEST PH-3363



The instrument is designed to determine the hardness of coatings by pencil leads according to: **ASTM D 3363, EN 13523-4, ISO 15184:2012, ECCA T4, JIS K 5600-5-4.**

DIN ISO Buchholz Coating Hardness Tester NOVOTEST BH-2815

Buchholz tester is used for hardness measurements of coatings using the indentation method (bevelled disc of steel block with constant test load).

Buchholz Coating Hardness Tester NOVOTEST BH-2815 is standardized according to: **DIN 53153, ISO 2815, BS 3900-E9, NF T30-052.**



COATING Testing



Scratch Hardness Coating Tester NOVOTEST SH-1518



Scratch Hardness Coating Tester NOVOTEST SH-1518 (ball type) is used for hardness testing of coatings (paint, mastic, plastic and others) through determining the hardness resistance to indentation of the ball tip with 1 mm diameter.

NOVOTEST SH-1518 is designed according to **ISO 6441**. Also it used for analysis the resistance of the coating for scratching (**ISO 1518**).

Erichsen Cupping Tester NOVOTEST SE-1520

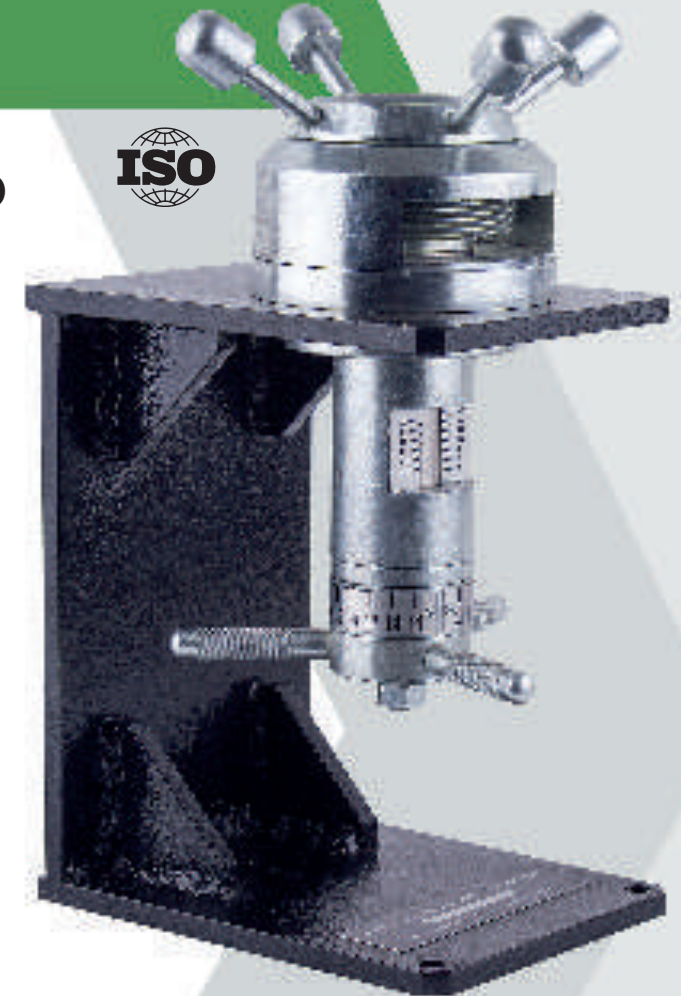

Erichsen Cupping Tester is designed for testing of elasticity and strength of coatings with cup-shaped curve, according to **ISO 1520**, **ISO 20482:2013**.

The Ericksen's device is used for determining the strength of the coating at the indentation of spherical tip punch with diameter of 20 mm in the coating of the sample, the position of which is fixed on a matrix with internal diameter of 27 mm.



Scratch Adhesion Tester NOVOTEST C1-5178

Device is used for determining the adhesion and resistance to damage by scratching method. The device complies with the requirements **ISO 12137-1**, **ASTM D 5178**, **ASTM D 2197**.



Impact Tester NOVOTEST STRIKE-U6272



NOVOTEST STRIKE-U6272 is designed for determining the strength of the film during the impact.

Construction of the instrument is made in accordance with modern requirements of **ISO 6272-2002** and **ISO 21809**.

The device is used for testing of metals, plastics, parquet, wood, ceramics, glass, concrete and screed.



COATING Testing



Bending Coating Tester NOVOTEST BEND-H1519

The device for testing the elasticity and strength of the coatings during bending around a set of cylindrical rods, with diameters of rods from 1 mm to 20 mm.



NOVOTEST BEND-H1519 complies with **ISO 1519-73**, **ASTM D 522**, **ISO6860** which applies to paints and varnishes and describe by method for determining the elasticity of the film bending.



Bending Coating Tester NOVOTEST BEND-M1519

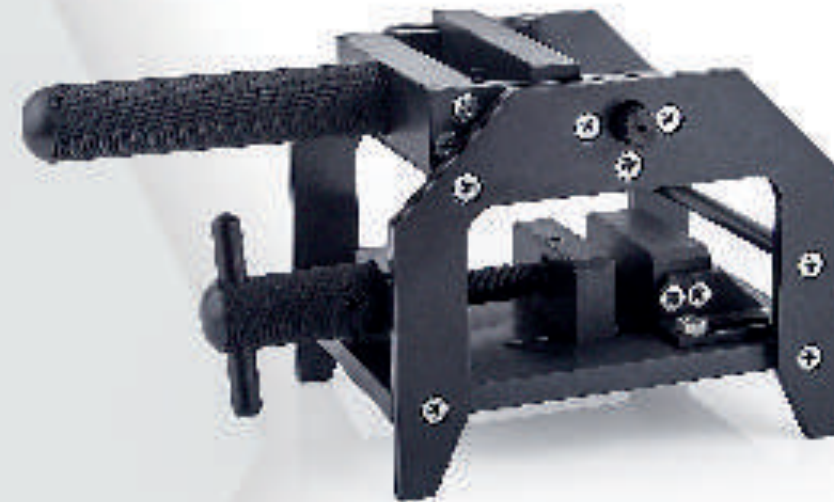

The device complies with **ISO 1519-73**, **DIN 53 152** and applies to paints and specifies a method for determining the elasticity of the film by bending.

The device allows to measure the elasticity and strength of coatings through bending the metal plate with tested coating around a set of cylindrical rods with diameters from 2 mm to 32 mm.



Bending Coating Mandrel Tester NOVOTEST BEND-H1500

The NOVOTEST BEND-H1500 is designed for determining the elasticity, adhesion, cracking of paint coatings on samples in accordance with **ASTM D 522-B**, **ASTM D 1737**, **AS/NZS 1580.402.1**, **BS EN3900-E1**, **DIN 53152**, **ISO 1519-1**, **NF T30-040**, **JIS K 5600-5-1**.

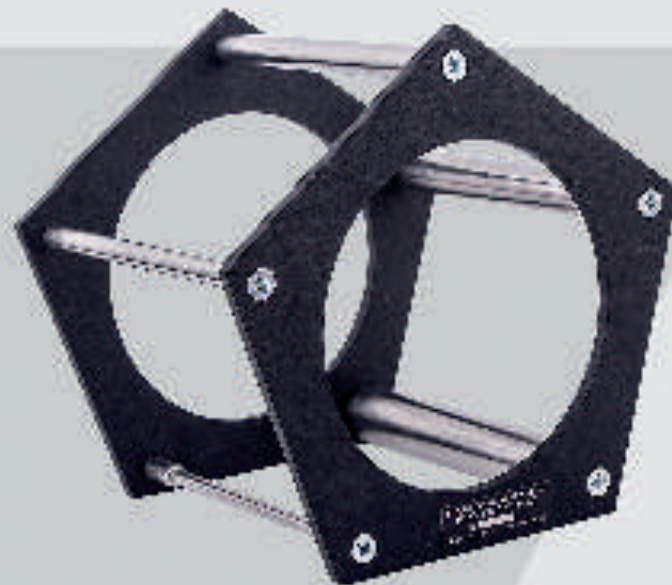
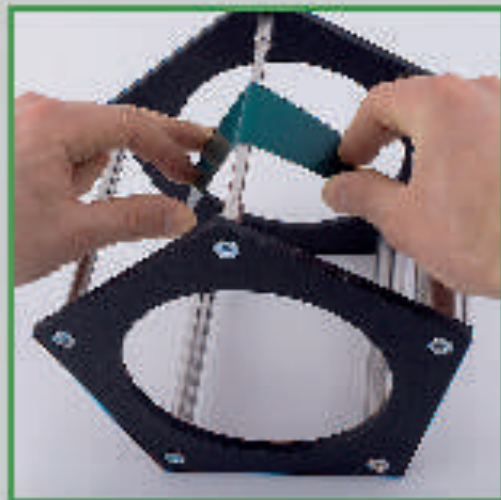

Bending Test Conical Mandrel NOVOTEST BEND-6860



The NOVOTEST BEND-6860 is used to determine the elasticity or resistance, adhesion and elongation of coatings on sheet metal in accordance with **ISO 6860**, **ASTM D 522-A**, **BS 3900-E11**, **ECCA T7**.

The sample is clamped against a conical mandrel and is bent around the mandrel by a roller mounted on a hand operated lever.

The diameter of the mandrel at the point where the coating of the sample starts to crack can be determined from a scale (3-37 mm) marked on the sample clamp.



CONSTRUCTION MATERIALS Testing



Strength Meter NOVOTEST IPSM-U+T+D (Pulse Velocity Tester)

Ultrasonic Tester of Building Materials (Concrete) Strength Meter IPSM-U+T+D is designed for rapid non-destructive testing of strength of concrete, composite bricks and other building materials. The device complies with **EN 12504-4**, **ASTM C 597-02**, **ISO 1920-7:2004**, **IS13311**, **CECS 21** standards.

Ultrasonic device allows measurement strength with surface sounding and through sounding methods by measuring the rate and time ultrasonic wave propagation in tested objects.

NOVOTEST IPSM-U+T+D is designed for detecting voids, cracks and defects that have arisen during manufacture and operation and measuring the depth of cracks in different objects.

The device has built-in memory and the ability to transmit saved measurements to PC.



Also it has: mode of the signal visualization (A-scan), the ability of testing concrete (and other) constructions for internal defects and discontinuities, also increases the accuracy of measuring time intervals by manual timing of the moment activation of measurer.

The device can be equipped with surface-sounding probe or/and probes for through-sounding.



Concrete Rebound Schmidt Hammer NOVOTEST SH



Concrete rebound Schmidt hammer is designed for strength testing of concrete and other building materials through impacting method, which is correspond with **ASTM C 805**; **ASTM D 5873**; **DIN 1048**; **ENV206**; **EN 12 504-2**; **ISO / DIS 8045**.



Concrete Cover Meter NOVOTEST Rebar Detector



The device is designed for rapid non-destructive testing of reinforced concrete products and structures in accordance to **BS 1881, Part 204**, **DIN 1045**, **DGZfP B2**, **SN 505262**, **SS 78-B4**.

NOVOTEST Rebar Detector operates on technology of magnetic fields and is used for technological testing at buildings and factories, as well as the planned examination of various structures and buildings.



Concrete Cover Meter NOVOTEST Rebar Detector works in a mode of constant scanning of the test surface.

For easy operation with the device, it has a function of sound search. Increasing the frequency of the audio signal indicates the oncoming of the probe to the reinforcing element that allows user to work without continuous monitoring of devices display.



Basic functions:

- Measuring the depth of reinforcement and its diameter;
- Identification of areas free of reinforcement structures;
- Operative control over the quality of reinforcement of reinforced concrete structures and products by magnetic methods in construction, on enterprises;
- Control of physical and technical characteristics when examining the integrity of buildings and structures.



MAGNETIC Testing

Steel Structure Analyzer NOVOTEST KRC-M-2

Steel Structure Analyzer (structurescope) is designed for non-destructive quality testing of chemical-thermal, thermal and thermo-mechanical treatments.

Steel Structure Analyzer allows to determine the mechanical properties and hardness of metals and to test the ferromagnetic products if there are any correlations between tested parameters.



In addition, the device is used for testing the surface layers of ferromagnetic materials and the metal for pre-sorting steel grades.

Magnetic Flux Detector (Permanent Magnetic Yoke) NOVOTEST MPD-DC



Magnetic flux detector is based on the method of non-destructive testing used for detecting violations of the magnetic surface of metal structures and structures of ferromagnetic materials.

In case of the ban regulations of the equipment with power supply, or difficulties with its supply, Magnetic Flux Detector NOVOTEST MPD-DC is the only one instrument for the required testing.



Magnetic Test Blocks NOVOTEST

Magnetic Test Blocks are used to check the sensitivity of magnetic particle and penetrant inspection materials.

Samples are available with different size of cracks, surface and subsurface defects and longitudinal and transverse indications.



Gaussmeter (magnetometer) NOVOTEST MF-1

Gaussmeter NOVOTEST MF-1 is a versatile and highly accurate diagnostic device that operates on the principle of Hall effect.

Magnetometer MF-1 is used for: determination of compliance of equipment to required specifications and the possibility of further testing, testing of the level of induction fields of tested object and components or devices during the diagnostic work with the method of magnetic particle, testing of level of residual magnetization, level of industrial noise, level of magnetic fields.



DISTRIBUTION NETWORK

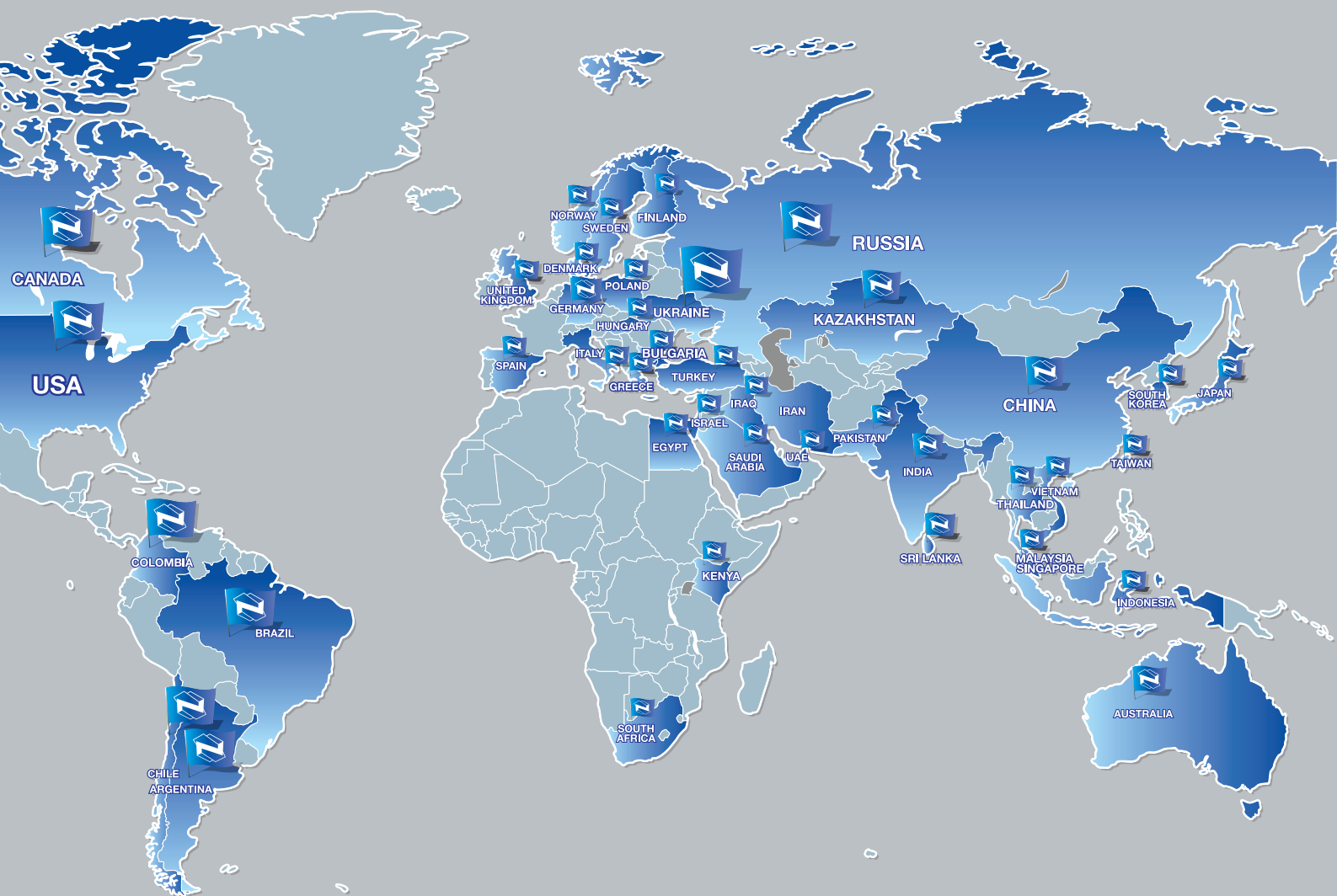

NOVOTEST

5, Spasskaya Street,
Novomoskovsk, 51200, Ukraine

E-mail: sales@novotest.biz

Skype: novotest_world

Phone: +380 (67) 593 59 77

+380 (56) 767 20 21

Fax: +380 (56) 935 87 44

www.novotest.biz

