



CYGNUS CATALOGUE 2021

ULTRASONIC THICKNESS GAUGES, HATCH COVER
LEAK DETECTOR & FLOODED MEMBER DETECTOR

Iss 17

Oct 2021 -Dec 2021

CONTENTS

Page



Surface Thickness Gauges, Probes & Leads

Cygnus 2 HANDS FREE	2
Cygnus 2+ HANDS FREE	3
Cygnus 4 GENERAL PURPOSE	4
Cygnus 4+ GENERAL PURPOSE	5
Cygnus 6+ PRO	6
HIGH TEMPERATURE KITS	7-8
Cygnus 1 INTRINSICALLY SAFE ATEX	9
Cygnus HEAVY DUTY	10



Subsea Thickness Gauges, Probes & Leads

Cygnus DIVE Mk2	11-13
Cygnus UNDERWATER	14
Cygnus ROV Mountable 2/4 km	15-16
Cygnus MINI ROV Mountable	17



Thickness Gauge Probes, Spares & Accessories

Cygnus Probes	18
Probe Leads	19
Knurled Rings & Membranes (spares)	20
Accessories	21
Carry Cases & Gauge Bodies	22
Spares for previous models	23



Flooded Member Detector

Cygnus FMD	24-25
------------	-------



Hatch Cover Leak Detector

Cygnus HATCH SURE	26
-------------------	----

Guide to Serial Numbers for Cygnus Gauges

27



Cygnus 2 HANDS FREE

Multiple Echo Ultrasonic Thickness Gauge

The Cygnus 2 HANDS FREE is housed in an extremely tough, rubber sealed enclosure with in-built display and extra durable buttons. Designed for use in rope access or belt mounted applications where the end-mounted organic LED display can be easily read whilst taking measurements. The Cygnus 2 is supplied in a protective carry case.



Cygnus 2 HANDS FREE Kit

Cygnus 2 HANDS FREE Mk5 UTG Kit, without Probe

Contents: Ultrasonic Thickness Gauge - 3 x AA batteries, steel test block - ultrasonic & membrane couplant - accessory pouch - neck & wrist straps & fixings - mini USB to USB cable - manual & carry case
(The gauge has a Lemo 1 connector)

Please select probe(s) & lead(s) from the lists below:

Order Code

050-2000/5



Single Crystal Probes for Cygnus 2 HANDS FREE Gauges

(All Probes are supplied with 20 membranes & membrane key)

Probe S2C Single 2.25MHz 13mm with BNC connector	004-9500
Probe S2D Single 2.25MHz 19mm with BNC connector	004-9502
Probe S3C Single 3.5MHz 13mm with BNC connector	004-9504
Probe S5C Single 5MHz 13mm with BNC connector	004-9508
Probe Lead Lemo 1 - BNC 1.4m (4'6")	004-0406



Probe S5A Single 5MHz 6mm with Single Lemo 00 connector	004-9507
---	----------

lead for use with the S5A probe & a Cygnus 2:

Probe Lead Single Lemo 1 - Single Lemo 00 1.35 m (4'6")	004-0401
---	----------



Right Angle Probe for Cygnus 2 HANDS FREE Gauges

(All right angle probes are supplied with 1.35 m integral probe lead with a Lemo 1 connector, 20 membranes & membrane key)

Right Angle Probe S2C 2.25MHz 13mm Lemo 1 (integral cable)	001-9387
Right Angle Probe S3C 3.5MHz 13mm Lemo 1 (integral cable)	001-9389
Right Angle S5A Probe 5MHz 6mm (1/4") Lemo 1(integral cable)	001-9390

Marinised (underwater) Probes for Cygnus 2 HANDS FREE Gauges

(Please add Marinised Cable length as required for all Marinised Probe orders. Cable includes a Lemo 1 connector to connect with the gauge)

Marinised Probe S2C 2.25MHz 13mm	002-9387
Marinised Probe S2D 2.25MHz 19mm	002-9388
Marinised cable for use underwater priced per metre	001-0434

(50m max. length for "S2-" (2.25MHz) probes, for other frequencies please contact Cygnus)

Accessories for Cygnus 2 HANDS FREE

Neck Strap with fixings for C2 / 2+ / 4 / 4+ / 6+ Mk5 UTG (supplied as part of gauge kit)	050-0115
--	----------

Hand Strap with fixing for C2 / 2+ / 4 / 4+ / 6+ Mk5 UTG (supplied as part of gauge kit)	050-0110
---	----------

Belt Clip with fixing for C2 / 2+ / 4 / 4+ / 6+ Mk5 UTG	050-0100
---	----------

Peli Carry Case for Cygnus 2 / 2+ / 4 Mk5 UTG Gauge Kit (Non discountable item)	050-4010/5
--	------------

For Spare Leads see page 17 & for Spare Knurled Rings & Membranes page 18



Cygnus 2⁺ HANDS FREE

Multi-Mode Ultrasonic Thickness Gauge

All the benefits of the Cygnus 2, plus it can be used in 3 measuring modes:

- * Multiple Echo with Single Crystal probes
- * Echo-Echo with Twin Crystal probes
- * Single Echo with Twin Crystal probes



Cygnus 2⁺ HANDS FREE Kit

Cygnus 2+ HANDS FREE Mk5 UTG Kit, without Probe

Order Code

050-2500/5

Contents: Ultrasonic Thickness Gauge - 3 x AA batteries, steel test block - ultrasonic & membrane couplant - accessory pouch, neck & wrist straps & fixings - mini USB to USB cable - manual & carry case (The gauge has a Twin Lemo 00 connector)

Please select probe(s) & lead(s) from the lists below:



Single Crystal Probes for Cygnus 2⁺ HANDS FREE Gauges

(All Probes are supplied with 20 membranes & membrane key)

Probe S2C Single 2.25MHz 13mm with BNC connector	004-9500
Probe S2D Single 2.25MHz 19mm with BNC connector	004-9502
Probe S3C Single 3.5MHz 13mm with BNC connector	004-9504
Probe S5C Single 5MHz 13mm with BNC connector	004-9508
lead for use with the above single crystal probes & a Cygnus 2+:	
Probe Lead Twin Lemo 00 to BNC 1.35m (4'6")	004-0410



Probe S5A Single 5MHz 6mm with Single Lemo 00 connector	004-9507
lead for use with the S5A probe & a Cygnus 2+:	
Probe Lead Twin Lemo 00 to Single Lemo 00 1.4m (4'6")	004-0412



Twin Crystal Probes for Cygnus 2+ HANDS FREE gauges

Probe T2C Twin 2MHz 17/12mm with Twin Lemo 00 Connector	004-9550
Probe T5B Twin 5MHz 13/8mm with Twin Lemo 00	004-9558
lead for use with the above twin crystal probes & a Cygnus 2+:	
Probe Lead Twin Lemo 00 to Twin Lemo 00 1.35m (4'6")	004-0411



Probe T5B-CSW 5MHz 13/8mm Side Exit Cable to Twin Lemo00	004-9590
Probe T5A Twin 5MHz 9.5/6.5mm Side Exit Cable to Twin Lemo 00	004-9560
Probe T7A-CSWB Twin 7.5MHz 6.5/4.5mm Side Exit Cable to Twin Lemo00	004-9591



4 Step Test Block for use with Twin Crystal Probes (non-discountable items)

Test Block Steel 4 Step Metric 2.5 - 20mm 2.5/5/10/20	001-4858
Test Block Steel 4 Step Imperial 0.1 - 0.75 inch	001-4859



Marinised (underwater) Probes for Cygnus 2+ HANDS FREE Gauges

Marinised Probe S2C 2.25MHz 13mm	002-9387
Marinised Probe S2D 2.25MHz 19mm	002-9388
Marinised cable for use underwater priced per metre	001-0434
(50m max. length for "S2-" (2.25MHz) probes, for other frequencies please contact Cygnus)	
Twin Lemo 00 to Single Lemo 1 adapter for C2+/C4+/C6+Mk5 UTG	050-0106
this adapter is required for using the above marinised probes with a "+" model Mk5 gauge	



Twin Lemo 00 to Single Lemo 1 adapter

Accessories for Cygnus 2⁺ HANDS FREE

Neck Strap with fixings for C2 / 2+ / 4 / 4+ / 6+ Mk5 UTG (supplied as part of gauge kit)	050-0115
Hand Strap with fixing for C2 / 2+ / 4 / 4+ / 6+ Mk5 UTG (supplied as part of gauge kit)	050-0110
Belt Clip with fixing for C2 / 2+ / 4 / 4+ / 6+ Mk5 UTG	050-0100
Peli Carry Case for Cygnus 2 / 2+ / 4 Mk5 UTG Gauge Kit (Non discountable item)	050-4010/5



For Spare Leads see page 17 & for Spare Knurled Rings & Membranes page 18



Cygnus 4 GENERAL PURPOSE

Multiple Echo Ultrasonic Thickness Gauge

A compact general purpose Ultrasonic Thickness Gauge (UTG) giving accurate, error-checked through-coating measurements using our Multiple Echo technology. Highly versatile, can be used either right or left handed, in most industrial or shipping applications. The LCD display is easily read outdoors and is perfect for use in all light conditions. Vibration alert settings for user feedback.



Cygnus 4 GENERAL PURPOSE Kit

Cygnus 4 GENERAL PURPOSE Mk5 UTG kit, without Probe

Order Code

050-4000/5

Contents: Ultrasonic Thickness Gauge - 3 x AA batteries - steel test block - ultrasonic & membrane couplant - accessory pouch - neck & wrist straps & fixings - mini USB to USB cable - manual & carry case (The gauge has a Lemo 1 connector)

Please select probe(s) & lead(s) from the lists below:



Probes for Cygnus 4 GENERAL PURPOSE Gauges

(All Probes are supplied with 20 membranes & membrane key)

Probe S2C Single 2.25MHz 13mm with BNC connector	004-9500
Probe S2D Single 2.25MHz 19mm with BNC connector	004-9502
Probe S3C Single 3.5MHz 13mm with BNC connector	004-9504
Probe S5C Single 5MHz 13mm with BNC connector	004-9508
lead for use with the above single crystal probes & a Cygnus 4	
Probe Lead Lemo 1 - BNC 1.4m (4'6")	004-0406



Probe S5A Single 5MHz 6mm with Single Lemo 00 connector	004-9507
lead for use with the S5A probe & a Cygnus 4	
Probe Lead Single Lemo 1 - Single Lemo 00 1.35 m (4'6")	004-0401



Right Angle Probes for Cygnus 4 GENERAL PURPOSE Gauges

(All right angle probes are supplied with 1.35 m integral probe lead with a Lemo 1 connector, 20 membranes & membrane key)

Right Angle Probe S2C 2.25MHz 13mm Lemo 1 (integral cable)	001-9387
Right Angle Probe S3C 3.5MHz 13mm Lemo 1 (integral cable)	001-9389
Right Angle S5A Probe 5MHz 6mm (1/4") Lemo 1(integral cable)	001-9390

Marinised (underwater) Probes for Cygnus 4 GENERAL PURPOSE Gauges

(Please add Marinised Cable length as required for all Marinised Probe orders. Cable includes a Lemo 1 connector to connect with the gauge)

Marinised Probe S2C 2.25MHz 13mm	002-9387
Marinised Probe S2D 2.25MHz 19mm	002-9388
Marinised cable for use underwater priced per metre	001-0434
(50m max. length for "S2-" (2.25MHz) probes, for other frequencies please contact Cygnus)	

Accessories for Cygnus 4 GENERAL PURPOSE

Neck Strap with fixings for C2 / 2+ / 4 / 4+ / 6+ Mk5 UTG (supplied as part of gauge kit)	050-0115
Hand Strap with fixing for C2 / 2+ / 4 / 4+ / 6+ Mk5 UTG	050-0110
Belt Clip with fixing for C2 / 2+ / 4 / 4+ / 6+ Mk5 UTG	050-0100
Peli Carry Case for Cygnus 2 / 2+ / 4 Mk5 UTG Gauge Kit (Non discountable item)	050-4010/5



For Spare Leads see page 17 & for Spare Knurled Rings & Membranes page 18



Cygnus 4+ GENERAL PURPOSE

Multi-Mode Ultrasonic Thickness Gauge



All the benefits of the Cygnus 4, plus A-Scan display and sequential data logging as standard. A data logging upgrade is also available to add extra data logging functions. The gauge can be used in 3 measuring modes:

- * Multiple Echo with Single Crystal probes
- * Echo-Echo with Twin Crystal probes
- * Single Echo with Twin Crystal probes

Cygnus 4+ GENERAL PURPOSE Kit

Order Code

Cygnus 4+ GENERAL PURPOSE Mk5 UTG Kit, without Probe

050-4500/5

Contents: Ultrasonic Thickness Gauge - with sequential data logging - 3 x AA batteries - steel test block - ultrasonic & membrane couplant - accessory pouch - neck & wrist straps & fixings - SD card - CylLink software - mini USB to USB data cable - manual & carry case (The gauge has a Twin Lemo 00 connector)

Please select probe(s) & lead(s) from the lists below:

Cygnus 4+ Mk5 software upgrade - added logging functions

adds grid logging & radial points facility

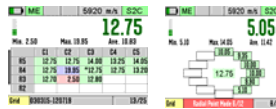

050-4520



Probes for Cygnus 4+ GENERAL PURPOSE Gauges

(All Probes are supplied with 20 membranes & membrane key)

Probe S2C Single 2.25MHz 13mm with BNC connector	004-9500
Probe S2D Single 2.25MHz 19mm with BNC connector	004-9502
Probe S3C Single 3.5MHz 13mm with BNC connector	004-9504
Probe S5C Single 5MHz 13mm with BNC connector	004-9508

lead for use with the above single crystal probes & a Cygnus 4+:

Probe Lead Twin Lemo 00 to BNC 1.35m (4'6")	004-0410
---	----------

Probe S5A Single 5MHz 6mm with Single Lemo 00 connector	004-9507
---	----------

lead for use with the S5A probe & a Cygnus 4+:

Probe Lead Twin Lemo 00 to Single Lemo 00 1.4m (4'6")	004-0412
---	----------

Twin Crystal Probes for Cygnus 4+ GENERAL PURPOSE gauges

Probe T2C Twin 2MHz 17/12mm with Twin Lemo 00 Connector	004-9550
Probe T5B Twin 5MHz 13/8mm with Twin Lemo 00	004-9558

lead for use with the above twin crystal probes & a Cygnus 4+:

Probe Lead Twin Lemo 00 to Twin Lemo 00 1.35m (4'6")	004-0411
--	----------

Probe T5B-CSW 5MHz 13/8mm Side Exit Cable to Twin Lemo00	004-9590
--	----------

Probe T5A Twin 5MHz 9.5/6.5mm Side Exit Cable to Twin Lemo 00	004-9560
---	----------

Probe T7A-CSWB Twin 7.5MHz 6.5/4.5mm Side Exit Cable to Twin Lemo00	004-9591
---	----------

4 Step Test Block for use with Twin Crystal Probes (non-discountable items)

Test Block Steel 4 Step Metric 2.5 - 20mm 2.5/5/10/20	001-4858
Test Block Steel 4 Step Imperial 0.1 - 0.75 inch	001-4859

Marinised (underwater) Probes for Cygnus 4+ HANDS FREE Gauges

Marinised Probe S2C 2.25MHz 13mm	002-9387
----------------------------------	----------

Marinised Probe S2D 2.25MHz 19mm	002-9388
----------------------------------	----------

Marinised cable for use underwater priced per metre	001-0434
---	----------

(50m max. length for "S2-" (2.25MHz) probes, for other frequencies please contact Cygnus)

Twin Lemo 00 to Single Lemo 1 adapter for C2+/C4+/C6+Mk5 UTG	050-0106
--	----------

this adapter is required for using the above marinised probes with a "+" model Mk5 gauge

Accessories for Cygnus 4+ GENERAL PURPOSE

Mini USB cable for data transfer	050-0120
----------------------------------	----------

(supplied as part of gauge kit)

Neck Strap with fixings for C2 / 2+ / 4 / 4+ / 6+ Mk5 UTG	050-0115
---	----------

(supplied as part of gauge kit)

Hand Strap with fixing for C2 / 2+ / 4 / 4+ / 6+ Mk5 UTG	050-0110
--	----------

(supplied as part of gauge kit)

Belt Clip with fixing for C2 / 2+ / 4 / 4+ / 6+ Mk5 UTG	050-0100
---	----------

Peli Carry Case for Cygnus 4+ Mk5 Gauge Kit	050-4511/5
---	------------

(Non discountable item)

For Spare Leads see page 17 & for Spare Knurled Rings & Membranes page 18



Twin Lemo 00 to Single Lemo 1 adapter



Cygnus 6+ PRO

Multi-Mode Ultrasonic Thickness Gauge

The Cygnus 6+ PRO has a front LED display plus an end mounted OLED display. It includes all the features of the 4+, plus comprehensive data logging, which includes grids, radial points & the facility to add bespoke templates. It has a B-Scan display. It also includes the option to choose manual gain control if required. The gauge can be connected to a computer either via the USB cable supplied or Bluetooth (please note the Bluetooth dongle is sold separately)



Cygnus 6+ PRO Kit

Cygnus 6+ PRO Mk5 UTG Kit, without Probe

Order Code

050-6500/5

Contents: Ultrasonic Thickness Gauge with comprehensive data logging - 3 x AA batteries, steel test block, ultrasonic & membrane couplant - accessory pouch - neck & wrist straps & fixings - SD card - CygLink software - mini USB to USB data cable - manual & carry case (The gauge has a Twin Lemo 00 connector)

Please select probe(s) & lead(s) from the lists below:



Probes for Cygnus 6+ PRO Gauges

(All Probes are supplied with 20 membranes & membrane key)

Probe S2C Single 2.25MHz 13mm with BNC connector	004-9500
Probe S2D Single 2.25MHz 19mm with BNC connector	004-9502
Probe S3C Single 3.5MHz 13mm with BNC connector	004-9504
Probe S5C Single 5MHz 13mm with BNC connector	004-9508
lead for use with the above single crystal probes & a Cygnus 6+:	
Probe Lead Twin Lemo 00 to BNC 1.35m (4'6")	004-0410



Probe S5A Single 5MHz 6mm with Single Lemo 00 connector	004-9507
lead for use with the S5A probe & a Cygnus 6+:	
Probe Lead Twin Lemo 00 to Single Lemo 00 1.4m (4'6")	004-0412



Twin Crystal Probes for Cygnus 6+ PRO gauges

Probe T2C Twin 2MHz 17/12mm with Twin Lemo 00 Connector	004-9550
Probe T5B Twin 5MHz 13/8mm with Twin Lemo 00	004-9558
lead for use with the above twin crystal probes & a Cygnus 6+:	
Probe Lead Twin Lemo 00 to Twin Lemo 00 1.35m (4'6")	004-0411
Probe T5B-CSW 5MHz 13/8mm Side Exit Cable to Twin Lemo00	004-9590
Probe T5A Twin 5MHz 9.5/6.5mm Side Exit Cable to Twin Lemo 00	004-9560
Probe T7A-CSWB Twin 7.5MHz 6.5/4.5mm Side Exit Cable to Twin Lemo00	004-9591



4 Step Test Block for use with Twin Crystal Probes (non-discountable items)

Test Block Steel 4 Step Metric 2.5 - 20mm 2.5/5/10/20	001-4858
Test Block Steel 4 Step Imperial 0.1 - 0.75 inch	001-4859



Marinised (underwater) Probes for Cygnus 6+ HANDS FREE Gauges

Marinised Probe S2C 2.25MHz 13mm	002-9387
Marinised Probe S2D 2.25MHz 19mm	002-9388
Marinised cable for use underwater priced per metre	001-0434
(50m max. length for "S2-" (2.25MHz) probes, for other frequencies please contact Cygnus)	
Twin Lemo 00 to Single Lemo 1 adapter for C2+/C4+/C6+Mk5 UTG	050-0106
this adapter is required for using the above marinised probes with a "+" model Mk5 gauge	

Accessories for Cygnus 6+ PRO

Mini USB cable for data transfer	050-0120
(supplied as part of gauge kit)	
Bluetooth Adapter V4.0 USB Belkin	050-0125
(not included in gauge kit - needs to be ordered if required)	
Neck Strap with fixings for C2 / 2+ / 4 / 4+ / 6+ Mk5 UTG	050-0115
(supplied as part of gauge kit)	
Hand Strap with fixing for C2 / 2+ / 4 / 4+ / 6+ Mk5 UTG	050-0110
(supplied as part of gauge kit)	
Belt Clip with fixing for C2 / 2+ / 4 / 4+ / 6+ Mk5 UTG	050-0100
Peli Carry Case for Cygnus 6+ Mk5 Gauge Kit	050-6511/5
(Non discountable item)	



For Spare Leads see page 17 & for Spare Knurled Rings & Membranes page 18



Cygnus 4+ High Temperature Kit

Order Code

050-4502/5

Supplied as a kit form *"Ready To Go"* for high temperature thickness measuring, with all of the additional benefits of our highly successful Cygnus 4+



The Cygnus 4+ High Temperature kit consists of the following items

1 off Cygnus 4+ gauge standard kit already loaded with the High Temperature firmware supplied with :3 x AA batteries - steel test block - standard ultrasonic & membrane couplant - accessory pouch - neck & wrist straps & fixings - SD card - CygLink

+ 1 off of the following items

PROBE T5B-MAUH 5MHz Twin element

Probe Lead Twin Lemo 00 to Microdot for T5B-MAUH

COUPLANT High Temperature (-45° to 412°C)



* Note - Alternative Stainless Steel braided lead version available on request

Cygnus 6+ PRO High Temperature Kit

Order Code

050-6502/5

Supplied as a kit form *"Ready To Go"* for high temperature thickness measuring, with all of the additional benefits of our highly successful Cygnus 6+



The Cygnus 6+ High Temperature kit consists of the following items

1 off Cygnus 6+ gauge standard kit already loaded with the High Temperature firmware supplied with :3 x AA batteries - steel test block - standard ultrasonic & membrane couplant - accessory pouch - neck & wrist straps & fixings - SD card - CygLink

+ 1 off of the following items

PROBE T5B-MAUH 5MHz Twin element

Probe Lead Twin Lemo 00 to Microdot for T5B-MAUH

COUPLANT High Temperature (-45° to 412°C)



* Note - Alternative Stainless Steel braided lead version available on request

Replacement Parts OR Ordering individual parts but NOT as a Kit

Order Code

PROBE T5B-MAUH 5MHz Twin element

004-9561



Probe Lead Twin Lemo 00 to Microdot for T5B-MAUH

004-0418



Probe Lead Twin Lemo 00 to Microdot S/S Braid

004-0417



COUPLANT High Temperature (-45° to 412°C)

001-3735



High Temperature Kit - Additional Standard Accessories

Probes for Cygnus 4+ & 6+ PRO Gauges

(All Probes are supplied with 20 membranes & membrane key)

Probe S2C Single 2.25MHz 13mm with BNC connector	004-9500
Probe S2D Single 2.25MHz 19mm with BNC connector	004-9502
Probe S3C Single 3.5MHz 13mm with BNC connector	004-9504
Probe S5C Single 5MHz 13mm with BNC connector	004-9508
lead for use with the above single crystal probes & a Cygnus 6+:	
Probe Lead Twin Lemo 00 to BNC 1.35m (4'6")	004-0410



Probe S5A Single 5MHz 6mm with Single Lemo 00 connector	004-9507
lead for use with the S5A probe & a Cygnus 6+:	
Probe Lead Twin Lemo 00 to Single Lemo 00 1.4m (4'6")	004-0412



Twin Crystal Probes for Cygnus 6+ PRO gauges

Probe T2C Twin 2MHz 17/12mm with Twin Lemo 00 Connector	004-9550
Probe T5B Twin 5MHz 13/8mm with Twin Lemo 00	004-9558
lead for use with the above twin crystal probes & a Cygnus 6+:	
Probe Lead Twin Lemo 00 to Twin Lemo 00 1.35m (4'6")	004-0411



Probe T5B-CSW 5MHz 13/8mm Side Exit Cable to Twin Lemo00	004-9590
Probe T5A Twin 5MHz 9.5/6.5mm Side Exit Cable to Twin Lemo 00	004-9560
Probe T7A Twin 7.5MHz 7.8/4.5mm Side Exit Cable to Twin Lemo 00	004-9575
Probe T5B-CSW 5MHz 13/8mm Side Exit Cable to Twin Lemo00	004-9590



4 Step Test Block for use with Twin Crystal Probes (non-discountable items)

Test Block Steel 4 Step Metric 2.5 - 20mm 2.5/5/10/20	001-4858
Test Block Steel 4 Step Imperial 0.1 - 0.75 inch	001-4859



Marinised (underwater) Probes for Cygnus 4+ & 6+ HANDS FREE Gauges

Marinised Probe S2C 2.25MHz 13mm	002-9387
Marinised Probe S2D 2.25MHz 19mm	002-9388
Marinised cable for use underwater priced per metre	001-0434
<i>(50m max. length for "S2-" (2.25MHz) probes, for other frequencies please contact Cygnus)</i>	
Twin Lemo 00 to Single Lemo 1 adapter for C2+/C4+/C6+Mk5 UTG	050-0106
<i>this adapter is required for using the above marinised probes with a "+" model Mk5 gauge</i>	

Accessories for Cygnus 6+ PRO

Mini USB cable for data transfer <i>(supplied as part of gauge kit)</i>	050-0120
Bluetooth Adapter V4.0 USB Belkin <i>(not included in gauge kit - needs to be ordered if required)</i>	050-0125
Neck Strap with fixings for C2 / 2+ / 4 / 4+ / 6+ Mk5 UTG <i>(supplied as part of gauge kit)</i>	050-0115
Hand Strap with fixing for C2 / 2+ / 4 / 4+ / 6+ Mk5 UTG <i>(supplied as part of gauge kit)</i>	050-0110
Belt Clip with fixing for C2 / 2+ / 4 / 4+ / 6+ Mk5 UTG	050-0100
Peli Carry Case for Cygnus 6+ Mk5 Gauge Kit (Non discountable item)	050-6511/5



For Spare Leads see page 17 & for Spare Knurled Rings & Membranes page 18



Cygnus 1 INTRINSICALLY SAFE ATEX

Multiple Echo Ultrasonic Thickness Gauge

A tough, ruggedised Ultrasonic Thickness Gauge (UTG) designed for safe use in potentially explosive environments. The Cygnus 1 INTRINSICALLY SAFE ATEX uses our Multiple Echo technology to take thickness measurements through protective coatings. It is supplied ready to use as a complete kit in a protective carry case with 2 rechargeable batteries.

ATEX Certification:

Group II Category 1G Ex ia IIC T6 Ga (Tamb = 0C to 45C)

Group I Category M1 Ex ia I Ma

Certificate No: BAS00ATEX1108

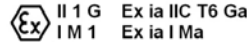

Nato Stock No: 5220-99-234-4651

Cygnus 1 INTRINSICALLY SAFE ATEX Kits

Order Code

Cygnus 1 INTRINSICALLY SAFE ATEX Mk3 UTG Kit, without Probe

001-9921/3

Contents: Ultrasonic Thickness Gauge - 2 rechargeable batteries - torque bar, ultrasonic & membrane couplant - 15mm/0.5" steel test block - battery charger - calibration jumper lead - trim tool - hex key - spare 'O'-rings - manual & carry case

Please select probe(s) from the list below:



Probes for Cygnus 1 INTRINSICALLY SAFE (IS) ATEX Gauges

(All Probes are supplied as nose cone assembly with 1 m cable, and with torque bar, 20 membranes and membrane key.)

Probe S2C 2.25MHz 13mm (1/2") for Cygnus 1 IS ATEX Mk3

001-9412-ATEX

Probe S2D 2.25MHz 19mm (3/4") for Cygnus 1 IS ATEX Mk3

001-9411-ATEX

Probe S3C 3.5MHz 13mm (1/2") for Cygnus 1 IS ATEX Mk3

001-9413-ATEX

Probe S5C 5MHz 13mm (1/2") for Cygnus 1 IS ATEX Mk 3 UTG

001-9344-ATEX

Probe S5A 5MHz 6mm (1/4") for Cygnus 1 IS ATEX Mk3 UTG

001-9345-ATEX



Right Angle Probes for Cygnus 1 INTRINSICALLY SAFE (IS) ATEX Gauges

(All Right Angle Probes are supplied as nose cone assembly with 1 m cable, and with torque bar, 20 membranes and membrane key.)

Right Angle Probe S2C 2.25MHz 13 mm for Cygnus 1 IS ATEX Mk3

001-9403

Right Angle Probe S3C 3.5MHz 13mm for Cygnus 1 IS ATEX Mk3

001-9405

Right Angle Probe S5A 5MHz 6mm for Cygnus 1 IS ATEX Mk3

001-9406

Right Angle Probe S5C 5MHz 13mm for Cygnus 1 IS ATEX Mk3

001-9407



General Spares for Cygnus 1 INTRINSICALLY SAFE (IS) ATEX

BATTERY for Cygnus 1 INTRINSICALLY SAFE ATEX Gauge Mk3

001-1505-ATEX

T6 Rated NiMH Battery for ATEX Gauges from Serial Number 3232. Supplied Uncharged.

Battery Charger for Cygnus UW / IS Mk3/4 (UK Mains Plug)

001-1514

Battery Charger for Cygnus UW / IS Mk3/4 (US Mains Plug)

001-1515

Battery Charger for Cygnus UW / IS Mk3/4 (EU Mains Plug)

001-1516

Calibration Jumper Lead for Cygnus 1 IS / UW / HD UTG

001-0410

Calibration Trim Tool

001-2600

1.5mm Hex Key for Cygnus 1 INTRINSICALLY SAFE UTG

001-2619

Nose Cone Torque Bar

001-2620

O Ring Pack for Cygnus 1 INTRINSICALLY SAFE UTG

001-3713

For Spare Knurled Rings & Membranes page 18

For Probes for Cygnus 1 INTRINSICALLY SAFE Mk 2 or Mk 1 (or below Serial No. 3232) page 21



Cygnus HEAVY DUTY

Multiple Echo Ultrasonic Thickness Gauge

A tough, ruggedised Ultrasonic Thickness Gauge (UTG) using Cygnus Multiple Echo technology, designed for use in demanding environments. The mechanical design of the Cygnus Heavy Duty has been proved and improved over nearly 30 years. This hardy and reliable tool is supplied ready to use as a complete kit in a protective carry case.



Nato Stock No: 5220-99-075-8576

Cygnus HEAVY DUTY Kits

Cygnus HEAVY DUTY Mk4 UTG Kit, without Probe

Contents: Ultrasonic Thickness Gauge - battery pack - torque bar - ultrasonic & membrane couplant - 15mm/0.5" steel test block - calibration jumper lead - spare 'O'-rings - manual & carry case

Please select probe(s) from the list below:

Order Code

001-9911/4



Probes for Cygnus HEAVY DUTY (HD) Gauges

(All Probes are supplied as nose cone assembly with 1 m cable, and with torque bar, 20 membranes and membrane key.)

Probe S2C 2.25MHz 13mm (1/2") for Cygnus HEAVY DUTY UTG
 Probe S2D 2.25 MHz 19mm (3/4") for Cygnus HEAVY DUTY UTG
 Probe S3C 3.5MHz 13mm (1/2") for Cygnus HEAVY DUTY UTG
 Probe S5C 5MHz 13 mm (1/2") for Cygnus HEAVY DUTY UTG
 Probe S5A 5MHz 6 mm (1/4") for Cygnus HEAVY DUTY UTG

001-9330
 001-9332
 001-9355
 001-9334
 001-9336



Right Angle Probes for Cygnus HEAVY DUTY (HD) Gauges

(All Right Angle Probes are supplied as nose cone assembly with 1 m cable, and with torque bar, 20 membranes and membrane key.)

Right Angle Probe S2C 2.25 MHz 13mm 1/2" for Cygnus HEAVY DUTY
 Right Angle Probe S3C 3.5MHz 13mm (1/2") for Cygnus HEAVY DUTY
 Right Angle Probe S5C 5MHz 13mm (1/2") for Cygnus HEAVY DUTY
 Right Angle Probe S5A 5MHz 6mm (1/4") for Cygnus HEAVY DUTY

001-9367
 001-9369
 001-9371
 001-9370



General Spares for Cygnus HEAVY DUTY (HD)

Battery Insert Plate (3 x AA) for Cygnus HEAVY DUTY Mk 3/4
 Battery Case (3 x AA) for Cygnus Heavy Duty (Mk3,4)
 Calibration Jumper Lead for Cygnus 1 IS / UW / HD UTG
 Calibration Trim Tool
 Nose Cone Torque Bar
 O Ring Pack for Cygnus Heavy Duty UTG

001-3723
 001-3722
 001-0410
 001-2600
 001-2620
 001-3718



For Spare Knurled Rings & Membranes page 18



Cygnus DIVE

Wrist-Mountable Underwater Thickness Gauge

The Cygnus DIVE, depth rated to 300 metres, is accurate, reliable and easy to use. The Cygnus DIVE is worn on the diver's forearm, availing an invaluable free hand while performing the thickness survey. A large, very bright colour AMOL display shows the thickness measurements in big numbers along with a live A-scan for verification. Power is supplied by replaceable, rechargeable, Lithium-Ion battery pack that gives up to 11 hours continuous measurement. The ultrasonic probe is connected by a coiled double jacket cable and rugged locking connector. Now with the option of Single Echo and Echo-Echo Modes for use with a Twin Crystal Probe, ideal for use on extremely heavy corrosion & anchor chain. Single Echo is for use on un-coated surfaces and Echo-Echo for use through paint up to 0.5mm thick. An optional data logging feature is available for storing up to 5000 measurements and A-Scans. CygLink v4, provides surface computer based viewing and data logging. The Topside Repeater unit with Video On-Screen Display option allows the thickness measurements to be overlaid onto the monitor screen / video recording of the survey. HelmetView provides a helmet-mounted remote display of thickness measurements.

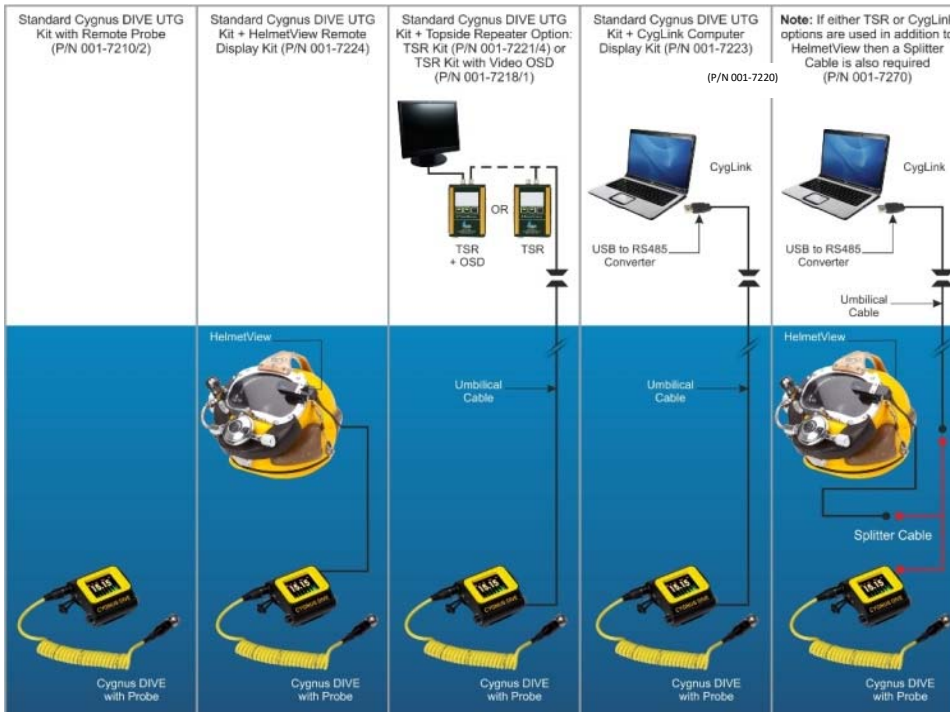

Cygnus DIVE Kits (see next page for Topside Kit options)

Cygnus DIVE Mk2 UTG Kit, without Probe Order Code 001-7200/2

Contents: Ultrasonic Thickness Gauge - 2 rechargeable batteries & charger - screen protector- silicone grease - lanyard - ultrasonic & membrane couplant - 15mm/0.5" steel test block - manual & carry case

Please select probe(s) & lead(s) from the lists below:

Cygnus Data Logging DIVE Mk2 UTG Kit, without Probe 001-7201/2

Contents: Ultrasonic Thickness Gauge - CygLink software on USB flash drive - Umbilical (9-way D) to PC (USB) link lead - DIVE (Fischer) direct to PC (USB) lead - 2 rechargeable batteries & charger - screen protector, silicone grease - lanyard - spare membranes - membrane key - ultrasonic & membrane couplant - 15mm/0.5" steel test block - manual & carry case

Please select probe(s) & lead(s) from the lists below:

Single Crystal Probes for Cygnus DIVE Gauge (Multiple Echo Mode)

(All Single Crystal Probes have integral coiled double-jacket cable and rugged locking connector, and are supplied with membrane key and a pack of 20 membranes.)

Probe S2C Single Crystal 2.25MHz 13mm 1/2" for Cygnus DIVE UTG	001-7230
Probe S3C Single Crystal 3.5MHz 13mm 1/2" for Cygnus DIVE UTG	001-7231
Probe S5C Single Crystal 5MHz 13mm 1/2" for Cygnus DIVE UTG	001-7232
Probe S5A Single Crystal 5MHz 6mm (1/4") for Cygnus DIVE UTG	001-7233

Twin Crystal Probe for Cygnus DIVE Gauge (Single Echo & Echo-Echo Modes)

(All Twin Crystal Probes have integral coiled double-jacket cable and rugged locking connector)

Probe T5B Twin Crystal 5MHz 13/8mm for DIVE Mk2 UTG	001-7235
Probe T2C Twin Crystal 2MHz 17/12mm for Cygnus DIVE Mk2 UTG	001-7236



Cygnus DIVE

Wrist-Mountable Underwater Thickness Gauge

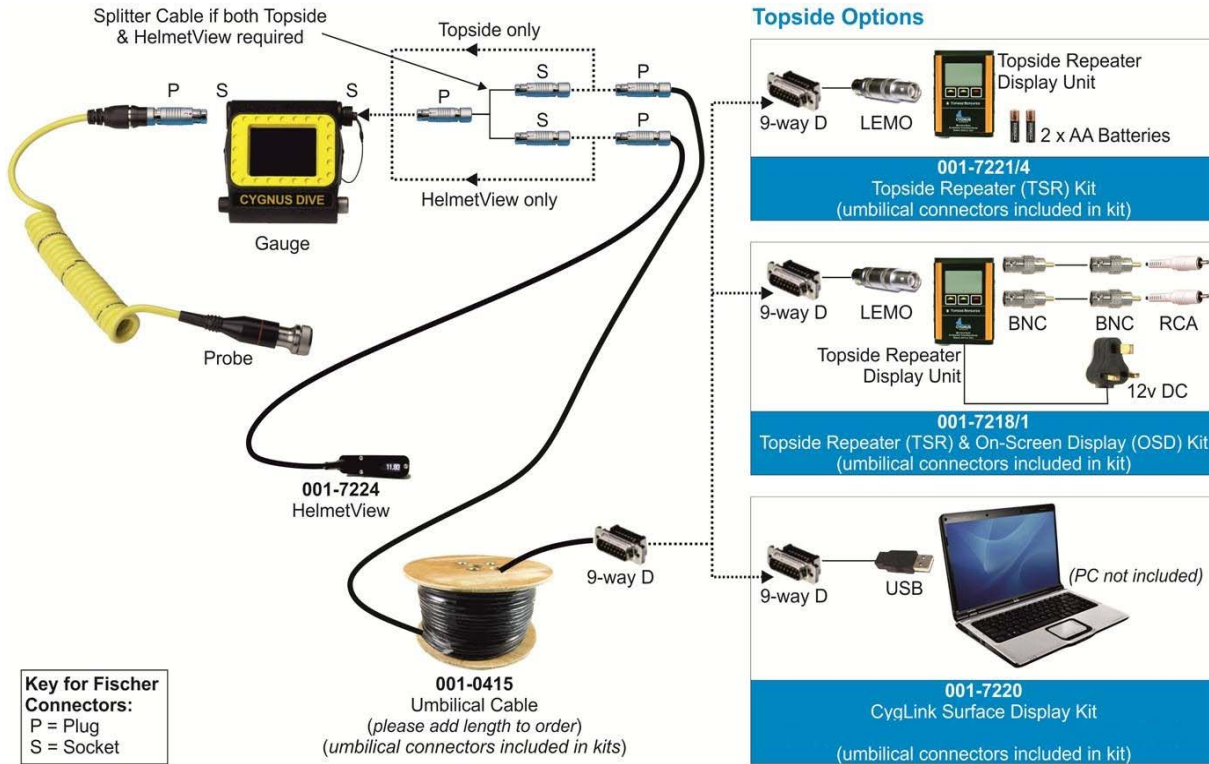

Surface/Topside Display Options for Cygnus DIVE Mk2 Gauge

Order Code

Topside Repeater (TSR) Kit for Cygnus DIVE UTG

001-7221/4

Upgrade Kit for Cygnus DIVE, to add Topside Repeater (TSR) Display Unit

Kit contents:

Cygnus Topside Repeater display unit - Silicone sleeve - Umbilical (9-way D) to TSR (Lemo) link lead - Cygnus DIVE (Fischer) to (9-way D) topside umbilical connectors - 2 x AA batteries

Please add to order: Umbilical cable (001-0415) & specify length

Topside Repeater (TSR) Kit with Video OSD for Cygnus DIVE

001-7218/1

Upgrade Kit for Cygnus DIVE to add Topside Repeater (TSR) Display Unit with Video On-Screen Display (OSD)

Contents: Cygnus Topside Repeater display unit - Silicone sleeve - Umbilical (9-way D) to TSR (Lemo) link lead - Cygnus DIVE (Fischer) to (9-way D) topside umbilical connectors - 2 BNC cables with RCA phono adapters - DC power supply 12 V universal plug-in

Please add to order: Umbilical cable (001-0415) & specify length

Surface Computer Logging feature for Cygnus DIVE UTG

001-7220

Upgrade Kit for Cygnus DIVE to add CygLink Surface Computer Display with Computer Data Logging Facility

Contents: Umbilical (9-way D) to computer (USB) link lead & Cygnus DIVE (Fischer) to (9-way D) topside umbilical connectors
CygLink software on USB

Please add to order: Umbilical cable (001-0415) & specify length

Umbilical cable for DIVE / UW / ROV to Topside (per metre)

001-0415

Note - The umbilical cable is NOT supplied with connectors, these are either supplied with the Topside repeater or have to be ordered separately



Cygnus DIVE

Wrist-Mountable Underwater Thickness Gauge

HelmetView for Cygnus DIVE Gauge

Order Code



HelmetView MK2 Remote Display Kit for Cygnus DIVE UTG

001-7224/2

An OLED display, integrated link lead to Cygnus DIVE (Fischer) & mounting brackets for Kirby Morgan helmets to display the thickness measurement in front of a diver's lens
(Suitable for use with DIVE Mk1 (orange gauge))

Splitter Cable for Cygnus DIVE HelmetView & Surface Display

001-7270

Splitter (Y) cable that enables both HelmetView (Fischer) & an umbilical cable (Fischer) for Topside display options to be connected to the Cygnus DIVE gauge (Fischer)

General Spares for Cygnus DIVE

CygLink Data Logging software upgrade for Cygnus DIVE

001-7219/2

Upgrade Kit for Cygnus DIVE Mk2 Ultrasonic Thickness Gauge (UTG) to add Data Logging Facility
Kit contents: Cygnus CygLink Software on USB Flash Drive - Cygnus DIVE Data Logger to USB Lead - Software Enabler Key (on USB Flash Drive)

Cygnus DIVE (Fischer) direct to computer (USB) Link Lead

001-7271

Umbilical (9-way D) to PC (USB) Link Lead for CygLink

001-7262

Umbilical (9-way D) to TSR Display Unit (Lemo) Link Lead

001-0426

Cygnus CygLink Topside Software on USB Flash Drive

001-8212

(Non discountable)

Video Cables and Adapters for Topside Repeater with OSD

001-0442

Cygnus DIVE (Fischer)-(9-way D) topside umbilical connectors

001-7260

Cygnus DIVE UTG Battery, uncharged (Watt Hour Rating: 8.1Wh)

001-7250

Battery Charger for Cygnus DIVE UTG (UK Mains Plug)

001-7251-UK

Battery Charger for Cygnus DIVE UTG (EU Mains Plug)

001-7251-EU

Battery Charger for Cygnus DIVE UTG (US Mains Plug)

001-7251-US

Screen Protector for Cygnus DIVE UTG

001-7263

Replacement Lanyard for Cygnus DIVE UTG

001-7257

Operation Manual for Cygnus DIVE Mk2 UTG Printed A5

001-7256/2

(Non discountable item)



Cygnus UNDERWATER

Diver-Held Underwater Thickness Gauge

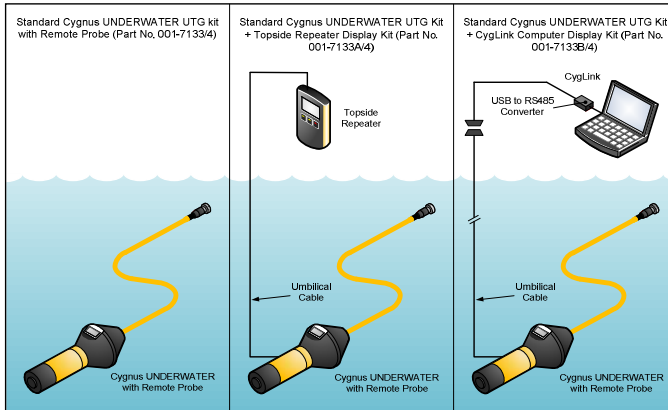

A tough underwater Ultrasonic Thickness Gauge (UTG) using our Multiple Echo technology, designed for divers undertaking subsea surveys. Pressure tested to 300 m depth and supplied ready to use as a complete kit in a protective carry case with 2 rechargeable batteries.

Cygnus UNDERWATER Kits

Cygnus UNDERWATER Mk4 UTG Kit, without Probe

Contents: Ultrasonic Thickness Gauge - 2 rechargeable batteries - torque bar - membrane couplant - steel test block - lanyard - battery charger - calibration jumper lead - silicone grease - spare probe knurled ring & gauge 'O'-rings - operation manual & carry case

Please select probe(s) from the list below:

Probes for Cygnus UNDERWATER Gauges

(All Probes are supplied as nose cone assembly with 1 m cable, and with torque bar, 20 membranes and membrane key.)

Probe S2C 2.25MHz 13mm (1/2") 1m cable for Cygnus Underwater/MINI ROV

Probe S2D 2.25MHz 19mm (3/4") for Cygnus Underwater UTG

Probe S3C 3.5MHz 13mm (1/2") for Cygnus Underwater UTG

Order Code

001-9933/4



001-9340

001-9341

001-9357



Surface/Topside Display Options

Upgrade Kit A for Cygnus UW to add Topside Repeater Unit (TSR)

for Cygnus UNDERWATER Ultrasonic Thickness Gauge with Topside Connector

Contents: Cygnus Topside Repeater (TSR) display unit - 2 AA batteries - silicone sleeve - Cygnus UNDERWATER (4-way Impulse) to TSR (Lemo 1) data connection

(Please add to order: Umbilical cable (001-0415) & specify length)

Upgrade Kit B (CygLink) for Cygnus UW to add surface computer logging

for Cygnus UNDERWATER Ultrasonic Thickness Gauge with Impulse connector

Contents: CygLink software, Cygnus UNDERWATER (4-way Impulse) to Topside (9-way D RS422) data connection, Isolated data converter (RS422/RS485 to USB)

(Please add umbilical cable (001-0415) & specify length)

Umbilical cable for DIVE / UW / ROV to Topside (per metre)

Note - The umbilical cable is NOT supplied with connectors, these are either supplied with the Topside repeater or have to be ordered separately

001-7133A

001-7133B

001-0415

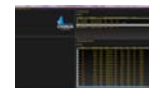

General Spares

Battery for Cygnus UNDERWATER Gauges Mk3/4 (Uncharged)

Battery Charger for Cygnus UW / IS Mk3/4 (UK Mains Plug)

Battery Charger for Cygnus UW / IS Mk3/4 (US Mains Plug)

Battery Charger for Cygnus UW / IS Mk3/4 (EU Mains Plug)

Calibration Jumper Lead for Cygnus 1 IS / UW / HD UTG

'O' Ring Pack for Cygnus UNDERWATER UTG

Contents: 20 sets of 'O' Ring A - 40 sets of 'O' Ring B/D - 20 sets of 'O' Ring C

Spares Kit for Cygnus UNDERWATER UTG

Contents: 'O'-rings (3 types: 20 x A - 40 x B - 20 x C) - silicone grease - 20 polyurethane membranes & 1 membrane key for each probe size (6mm - 13mm & 19mm) & membrane couplant

Impulse Connector 4-Way with Flying Lead LPMIL-4-MP

Impulse Connector 4-Way Blanking Plug IE-LPMDC-4-MP

Connectors for umbilical UW UTG (Impulse) to TSR (Lemo)

Connectors for umbilical Cygnus UW UTG (Impulse) to PC (9D)

Isolated Data Converter (RS422/RS485 to USB)

Topside Interface Cable A (Lemo socket) to B (9-way D plug)

Topside Interface Cable B (9-way D socket) to A (Lemo plug)

CygLink Software and Underwater Gauge Manual on USB stick

Lanyard for Cygnus UNDERWATER UTG

For Spare Knurled Rings & Membranes page 18

001-1504

001-1514

001-1515

001-1516

001-0410

001-3711

001-3715

001-0418

001-0419

001-0414

001-0413

001-8305

001-0416

001-0417

001-8210

001-4822

(Non discountable)



Cygnus ROV MOUNTABLE 2/4 km

Multiple Echo Ultrasonic Thickness Gauges

Available in 2000 m and 4000 m depth rated housings, these units are truly versatile and designed to operate in the harshest deepsea operating conditions. Dedicated software displays the time, date and thickness measurements on the surface which can be stored or logged. Alternatively, an optional Topside Repeater is available which has the facility to display readings remotely and overlay them onto a video signal which allows the measurements to be superimposed on the ROV camera's monitor screen.

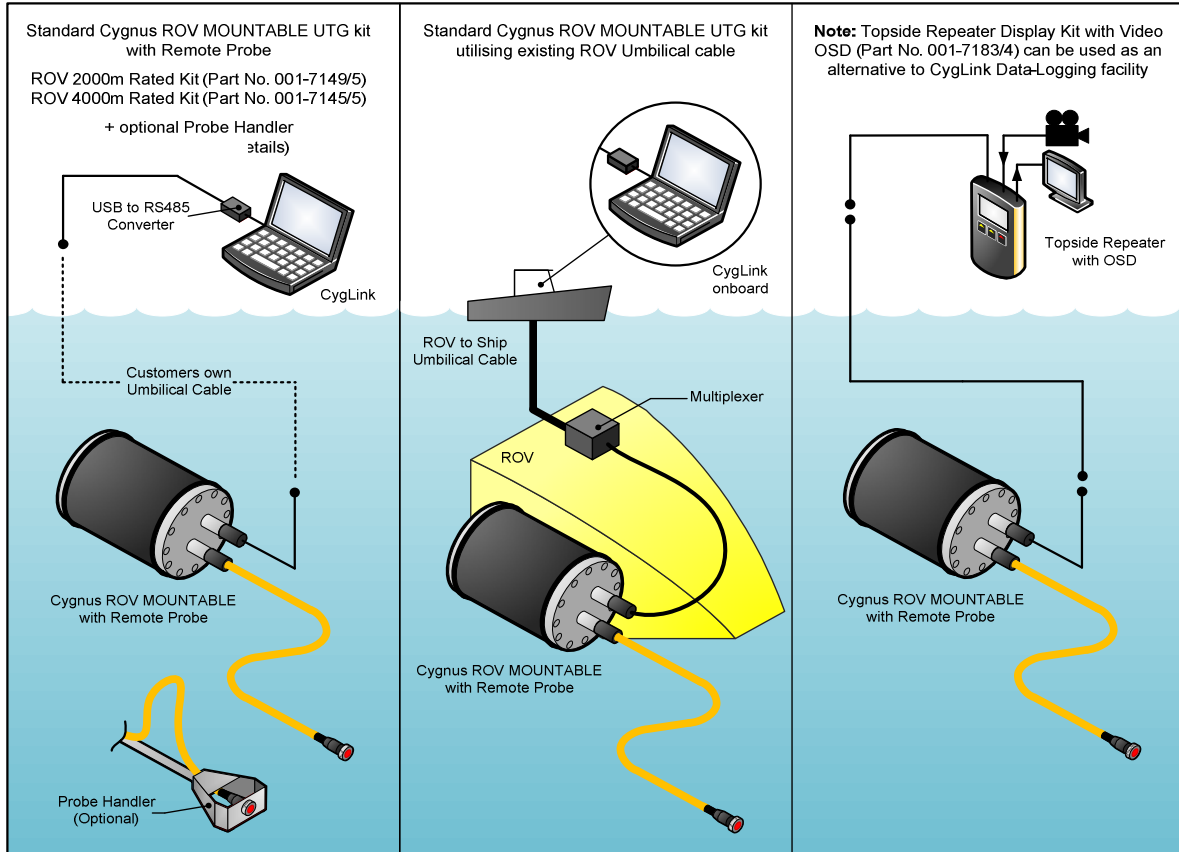

Cygnus ROV MOUNTABLE 2000 m / 4000 m Kits

Cygnus ROV 2000m Mk5 UTG Kit, without Probe

Contents: Ultrasonic Thickness Gauge - power & data test cable - gauge (Subconn) to umbilical (flying) lead - 9-way D connector - 'K3' RS422 to RS232 converter - RS232 to USB serial interface cable - Cyglink data logging software - spare 1A fuses - 3 mm allen key - silicone grease - spare 'O'-rings - ultrasonic & membrane couplant - steel test block - manual & carry case

Please select probe(s) from the list below:

Cygnus ROV 4000m Mk5 UTG Kit, without Probe

Contents: Ultrasonic Thickness Gauge - power & data test cable - gauge (Subconn) to umbilical (flying) lead - 9-way D connector - 'K3' RS422 to RS232 converter - RS422/RS485 to USB converter - Cyglink data logging software - spare 1A fuses - 3 mm allen key - silicone grease - spare 'O'-rings - 20 membranes - membrane key - ultrasonic & membrane couplant - steel test block - manual & carry case

Please select probe(s) from the list below:

Order Code

001-9949/5

001-9945/5

Probes for Cygnus ROV MOUNTABLE 2000 m / 4000 m Gauges

(All Probes are supplied with 5 m cable (unless otherwise customised) and with 20 membranes and membrane key.)

Probe S2C 2.25MHz 13mm for Cygnus ROV 2/4km Mk5 - 5m cable

001-9393

Probe S2D 2.25MHz 19mm for Cygnus ROV 2/4km Mk5 - 5m cable

001-9395



For Probes to fit Cygnus ROV Probe Handlers see next page



Cygnus ROV MOUNTABLE 2/4 km

Multiple Echo Ultrasonic Thickness Gauges

Surface/Topside Display Option for Cygnus ROV MOUNTABLE Gauges

Order Code

Topside Repeater (TSR) Kit with Video OSD for ROV 2000/4000m

001-7183/4

Contents: Topside Repeater Surface Display Unit with On-Screen Video Overlay Facility - BNC Video Leads and RCA Connectors - 12 VDC Power Supply (UK/US/EUR) - one set of Umbilical Connectors with Tails & Silicone Sleeve. On-Screen Video Overlay is suitable for connecting into composite video feeds (PAL or NTSC)



Cygnus ROV Probe Handlers

G1 Inspection ROV PROBE HANDLER without Probe

001-8351



Cygnus S1 Hull Inspection ROV PROBE HANDLER, without Probe

001-8331



Cygnus W1 Work Class ROV PROBE HANDLER, less Probe & Handle

001-8311

Fishtail Manipulator Handle

001-8316

3/4" T-Bar Manipulator Handle

001-8314

1/2" T-Bar Manipulator Handle

001-8315



Probes for Cygnus ROV Probe Handlers

Probe S2C 2.25MHz 13mm long body Right Angled for W1 & ROV 2/4km 5m Cable

001-8364

Probe S2C 2.25MHz 13mm 1/2" for G1 & ROV 2000/4000m (1m cable)

001-8355

Probe S2C 2.25MHz 13mm for S1 & ROV 2000/4000m UTG 1m cable

001-8335

General Spares for Cygnus ROV MOUNTABLE 2000 m / 4000 m Gauges

RS232 to USB Serial interface cable

003-0422

Isolated Data Converter RS422 to RS232 Model K3

001-8308

CygLink Topside Data Logging Software for Cygnus Mk5 ROV's

003-8213

Video Cables and Adapters for Topside Repeater with OSD

001-0442

Power & Data Connector for 2000/4000m ROV with flying lead

001-0431

Data Test & Power Cable RS232/422 for 2000/4000M ROV UTG

001-0439

Umbilical cable for DIVE / UW / ROV to Topside (per metre)

001-0415

Umbilical cable connectors for ROV 2000/4000m UTG to laptop

001-7185

Umbilical cable connectors for ROV 2000/4000m UTG to TSR

001-7186

Spares Kit for Cygnus ROV Mountable 2000m/4000m UTG

001-3719



(Non discountable)

For Spare Knurled Rings & Membranes page 18



Cygnus MINI ROV MOUNTABLE

Multiple Echo Ultrasonic Thickness Gauge

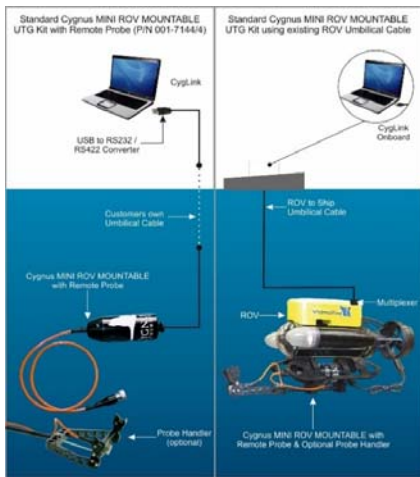

The Cygnus MINI ROV Mountable ultrasonic thickness gauge (UTG) is designed to be mounted onto small, observation ROVs, with or without a manipulator facility. Dedicated software displays the time, date and thickness readings on the surface which can all be logged. Alternatively, an optional Topside Repeater (TSR) display unit is available, which has the facility to display measurements remotely and overlay them onto a video signal. Therefore measurements can be superimposed on the ROV camera's monitor screen.



Cygnus MINI ROV Mountable Kits (Pressure tested to 500 m,

Order Code

Cygnus MINI ROV 500m Mk4 UTG Kit without Probe

001-9944/4

Contents: Ultrasonic Thickness Gauge - power and data test cable - gauge (4-way 'Impulse' connector) to umbilical (flying) lead - 'Impulse' blanking plug - 9-way D connector, K3' RS422 to RS232 converter - RS232 to USB Serial interface cable - CygLink data logging software - silicone grease - spare 'O'-rings - torque bar - ultrasonic & membrane couplant - 15mm/0.5" steel test block - manual & carry case

Please select probe(s) from the list below:

Probes for Cygnus MINI ROV Mountable Gauge

(All Probes are supplied as nose cone assembly with 1 m cable, and with torque bar, 20 membranes and membrane key.)

Probe S2C 2.25MHz 13mm (1/2") 1m cable for Cygnus Underwater/MINI ROV

001-9340

Probe S2D 2.25MHz 19mm for Cygnus MINI ROV MOUNTABLE UTG

003-9410

Cygnus ROV Probe Handlers and Probes

G1 Inspection ROV PROBE HANDLER without Probe

001-8351

Probe S2C 2.25MHz 13mm (1/2") for G1 & MINI ROV UTG (1m cable)

001-8354

Cygnus S1 Hull Inspection ROV PROBE HANDLER, without Probe

001-8331

Probe S2C 2.25MHz 13mm (1/2") for S1 & MINI ROV UTG (1m cable)

001-8334

Surface/Topside Display Option for Cygnus MINI ROV Mountable Gauge

Topside Repeater Kit with Video OSD for Cygnus MINI ROV UTG

001-7153/4

Contents: Topside Repeater Surface Display Unit with On-Screen Video Overlay Facility - BNC Video Leads & RCA Connectors - 12 VDC Power Supply (UK/US/EUR) - Lemo to 9way D Connection Lead & Silicone Sleeve. On-Screen Video Overlay is suitable for connecting into composite video feeds (PAL or NTSC)

VideoRay Fittings for Cygnus MINI ROV Mountable Gauge

VideoRay Mounting Kit incl. brackets, fittings, cable

001-8309

for use with Cygnus MINI ROV includes: mounting brackets - fittings & connection cable (4-way Impulse to 9-way SubConn) (Skids not included)

General Spares for Cygnus MINI ROV Mountable Gauge

O Ring Pack for Cygnus MINI/1000m /3000m ROV Mountable UTG

001-3712

Kit contents: 20 x 'O'-ring type A and 20 x 'O'-ring type B.

RS232 to USB Serial interface cable

003-0422

Isolated Data Converter RS422 to RS232 Model K3

001-8308

CygLink Software & manual on USB for MINI ROV UTG

001-8333

Impulse Connector 4-Way Blanking Plug IE-LPMD-4-MP

001-0419

Impulse Connector 4-Way with Flying Lead LPMIL-4-MP

001-0418

Test Cable - Impulse to 9 way 'D' Connector with DC Power

001-0432

Video Cables and Adapters for Topside Repeater with OSD

001-0442

Umbilical cable for DIVE / UW / ROV to Topside (per metre)

001-0415

Note - The umbilical cable is NOT supplied with connectors, these are either supplied with the Topside repeater or have to be ordered separately

Mini M4 ROV test cable parts (4 way connector for signal and power) - Umbilical cable to be ordered 001-7154

For Spare Knurled Rings & Membranes page 18





(Non discountable)



Cygnus Probes





for use with Cygnus Ultrasonic

Single Crystal Probes for use with gauges in Multiple Echo Mode:

Probe Type	Band Colour	Frequency	Crystal Size ϕ	Crystal Size ϕ	Measuring Range in Steel	Probe Connectors	
S2C	Red	2.25 MHz	13mm / 0.512"	13mm / 0.512"	3 - 250mm / 0.118" - 9.842"	BNC	
S3C	Orange	3.5MHz	13mm / 0.512"	13mm / 0.512"	2 - 150mm / 0.078" - 5.905"		
S5C	Black	5.0 MHz	13mm / 0.512"	13mm / 0.512"	1 - 50mm / 0.039" - 1.968"		
S5A	Black	5.0 MHz	6mm / 0.236"	6mm / 0.236"	1 - 50mm / 0.039" - 1.968"	Lemo 00	
S2D	Red	2.25 MHz	19mm / 0.748"	19mm / 0.748"	3 - 250mm / 0.118" - 9.842"	BNC	

Suitable for surface temperatures up to 75°C (167°F) with standard membranes & 150°C (302°F) with Teflon membranes, please see page 19 for membrane details

Twin Crystal Probes for use in Echo-Echo & Single Echo Modes:

Probe Type	Frequency & Crystal ϕ	Tip Size	Range in Steel (Single-Echo)	Range in Steel (Echo-Echo)	Typical Applications	Crystal	Probe connectors	Weight	Temperature Range	
T2C-CSL	2 MHz 12mm (0.5")	17mm (0.67")	2.5 - 350mm (0.1 - 13.8")	5 - 50mm (0.20 - 2")	<input type="checkbox"/> Attenuative materials	Composite	Twin Lemo 00	56g (1.98oz)	-10 to 70°C (14 to 158°F)	
T5B-CSL	5 MHz 9.5mm (0.37")	12.7mm (0.5")	1.5 - 200mm (0.059 - 7.90")	4 - 50mm (0.16 - 2")	<input type="checkbox"/> General purpose <input type="checkbox"/> Surfaces with heavily corroded & pitted front/back walls	Composite	Twin Lemo 00	61 g (2.15oz)	-10 to 70°C (14 to 158°F)	
T5A-CSW	5 MHz 6.4 mm (0.25")	9.5mm (0.37")	1 - 150mm (0.039 - 5.91")	3 - 50mm (0.12 - 2")	<input type="checkbox"/> General purpose	Composite	Wired to Lemo 00	81.7g (2.89oz) Inc cable	-10 to 70°C (14 to 158°F)	
T5B-CSW	5 MHz 9.5mm (0.37")	12.7mm (0.5")	1.5 - 200mm (0.059 - 7.9")	4 - 50mm (0.16 - 2")	<input type="checkbox"/> General purpose	Composite	Wired to Lemo 00	9g (3.2oz) Inc cable	0 to 60°C (32 to 140°F)	
T7A-CSWB	7.5 MHz 4.5mm (0.18")	6.5mm (0.256")	0.8 - 50mm (0.031 - 2")	3 - 25mm (0.12 - 1")	<input type="checkbox"/> Small diameter pipes <input type="checkbox"/> Thin, corroded plate	Composite	Wired to Lemo 00	68g (2.39oz) Inc cable	-10 to 70°C (14 to 158°F)	

Probe Type reference key:

First Group (e.g. T5B)			Second Group (e.g. CSW)		
First Letter	Middle Number Frequency in MHz	Last Letter Crystal Size ϕ	First Letter	Second Letter	Last Letter
S = Single T = Twin	2 = 2 MHz / 2.25 MHz 3 = 3.5 MHz 5 = 5 MHz 7 = 7.5MHz	Refer to the charts above	C = Composite	S = Side entry	L = Lead version W = Wired version

Example T5B-CSW = **T**win, **5**MHz, **B** 9.5mm Crystal - **C**omposite, **S**ide Entry, **W**ired



Cygnus Probe Leads

for use with Cygnus Ultrasonic Thickness Gauges



Leads for use with Cygnus 2 & 4 Mk5 & Cygnus 3 Mk4 Gauges

	<i>Order Code</i>
Probe Lead Lemo 1 - BNC 1.4m (4'6")	004-0406
Probe Lead Single Lemo 1 - Single Lemo 00 1.35 m (4'6")	004-0401
Probe Lead RG58 Lemo 1S to BNC 1.35m (4'6")	004-0405

Leads for use with Cygnus 2+ & 4+ Mk5 Gauges

Probe Lead Twin Lemo 00 to BNC 1.35m (4'6")	004-0410
Probe Lead Twin Lemo 00 to Single Lemo 00 1.4m (4'6")	004-0412
Probe Lead Twin Lemo 00 to Twin Lemo 00 1.35m (4'6")	004-0411



Cygnus Membranes & Knurled Rings (spares)

for use with Cygnus Single-Crystal Ultrasonic Probes

All Cygnus single-crystal probes are constructed from stainless steel and incorporate a replaceable wear membrane to protect the probe face. The performance of the probe depends on the condition of the membrane and how well it has been fitted. Please refer to your Operation Manual for guidelines on changing the protective membrane on Cygnus Probes.

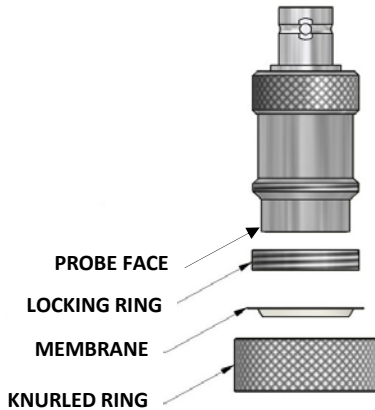

Important note: the actual Membrane Diameter is larger than the "Probe Size" that it is designed to fit. The "Probe Size" is defined by the diameter of the black part of the Probe Face. Please order membranes according to "Probe Size" as per the below table:

Standard Membranes

(Standard membranes are made of polyurethane and are suitable for surface temperatures up to 75°C (167°F). Available in packs of 20.)

	Order Code	Membrane Diameter	Probe Face Diameter
Polyurethane Membranes for 19 mm (3/4") Probes - pack of 20	001-3700	30 mm	22 mm Probe
Polyurethane Membranes for 13 mm (1/2") Probes - pack of 20	001-3701	21 mm	15 mm Probe
Polyurethane Membranes for 6 mm (1/4") Probes - Pack of 20	001-3702	14 mm	10 mm Probe

Higher Temperature Membranes

(Higher temperature membranes are made of Teflon and are suitable for surface temperatures up to 150°C (302°F), with a maximum contact time of 5 seconds. Available in packs of 10.)

	Order Code	Membrane Diameter	Probe Size
Teflon Membranes for 19 mm (3/4") Probes - pack of 10	001-4875	21 mm	19 mm Probe
Teflon Membranes for 13 mm (1/2") Probes - pack of 10	001-4874	19 mm	13 mm Probe
Teflon Membranes for 6 mm (1/4") Probes - pack of 10	001-4873	13 mm	6 mm Probe

Knurled Rings and Membrane (or Locking Ring) Keys

Knurled Ring Assembly for 19 mm (3/4") Probes	001-3705
Knurled Ring Assembly for 13 mm (1/2") INOX Probes	001-3709
Knurled Ring Assembly for 13 mm (1/2") Probes	001-3704
Knurled Ring Assembly for 6 mm (1/4") Probes	001-3703
Membrane Key for 19 mm (3/4") Probes	001-2610
Membrane Key for 13 mm (1/2") Probes	001-2611
Membrane Key for 6 mm (1/4") Probes	001-2612

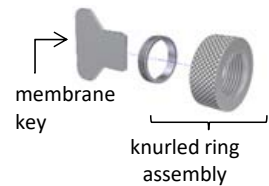

Cygnus Accessories



Couplant

	Order Code	
Couplant UCA-2M (1 litre tub)	001-3707	 Membrane couplant
Couplant UltraSonix High Performance Gel (118ml)	001-3708	
Membrane Couplant 25 ml bottle	001-3706	

Grease for use with UNDERWATER & DIVE Gauges

Silicone Grease 50g Tube	001-4861
--------------------------	----------

Test Blocks

Steel Test Block 15 mm <i>(not supplied with a calibration certificate)</i>	001-4850	
Steel Test Block 1/2" <i>(not supplied with a calibration certificate)</i>	001-4851	
Test Block Stainless Steel 15 mm <i>(not supplied with a calibration certificate)</i>	001-4854	
Test Block Aluminium 15 mm <i>(not supplied with a calibration certificate)</i>	001-4857	
4 Coating Test Block <i>(Non discountable item) (not supplied with a calibration certificate)</i>	001-4888	
3 Area Coated Test Block <i>(Non discountable item) (not supplied with a calibration certificate)</i>	001-4887	3 Area Coated Test Block 
Test Block Steel 4 Step Metric 2.5 - 20mm 2.5/5/10/20 <i>(Non discountable item) (not supplied with a calibration certificate)</i>	001-4858	4 Step Test Block 
Test Block Steel 4 Step Imperial 0.1 - 0.75 inch <i>(Non discountable item) (not supplied with a calibration certificate)</i>	001-4859	
Calibration Block - Steel 4 Step Metric 2.5-20mm <i>(Non discountable item) Traceable calibration certificate supplied</i>	001-4876	
Calibration Block - Steel 4 Step Imperial 0.1" - 0.75" <i>(Non discountable item) Traceable calibration certificate supplied</i>	001-4877	
Calibration Block Carbon Steel 5-25 mm 5 mm steps in perspex <i>(Non discountable item) Dimensional and material type certificate supplied</i>	001-4856	Carbon Steel Step Block in perspex & 15mm Test Blocks 

Pit Gauges

Cygnus Mechanical Pit Gauge <i>(Measurement Range: 0 to 43 mm)</i>	111-7165	 Pit Gauge
---	----------	---

Surface Preparation Accessories

Chipping/Boiler Scaling Hammer 1lb Ash Handle	500-0100	 Hammer
Carbide Edged Power Scraper	500-0101	
Steel Wire Brush & Scraper	500-0102	

Brush & Scraper

Cygnus Manuals

Cygnus Gauge manuals are available to download from the support section of our website, if the manual you require is not available for any reason please contact us on sales@cygnus-instruments.com and we will be happy to email it. Paper copies are available for £8.00 plus carriage



Carry Cases & Gauge Bodies for current range

Carry cases, pouches, sleeves, slings & straps (Peli Cases Non Discountable)

Order Code

for Surface Thickness Gauges

Soft Carry Case + foam for C2 / 2+ / 4 / 4+ / 6+ Mk5 UTG Kit	050-0105
2x Neck Strap fixings for C2 / 2+ / 4 / 4+ / 6+ Mk5 UTG	050-0116
Silicone Sleeve for Cygnus 4 GENERAL PURPOSE Mk4 or TSR	004-4835
Fabric Accessories Pouch	002-4837/4
Hard Carry Case for Cygnus 1 IS & HD UTG Kits	001-4800
Peli Carry Case for Cygnus 2 / 2+ / 4 Mk5 UTG Gauge Kit	050-4010/5
Peli Carry Case for Cygnus 4+ Mk5 Gauge Kit	050-4511/5
Peli Carry Case for Cygnus 6+ Mk5 Gauge Kit	050-6511/5

for Subsea Thickness Gauges

Peli Carry Case for Cygnus DIVE MK2 UTG (Yellow)	001-7252/2
Peli Carry Case for Cygnus UNDERWATER UTG Kit (Yellow)	001-4813-UW
Peli Carry Case for Cygnus M5-ROV-2K/4K UTG Kit (Yellow)	001-4813-ROV

for Hatch Sure

Ruck sack style soft carry case for Hatch Sure Mk1 Kit	006-1009
Protective Pouch with Sling for Hatch Sure Mk1 Transmitter	006-1011
Protective Pouch for Hatch Sure Mk1 Receiver	006-1014
Waist Strap for Cygnus Hatch Sure Mk1 Receiver	006-1015

Gauge Bodies (latest electronics available only)

Cygnus 2 HANDS FREE Mk5 UTG body only	050-2011/5
Cygnus 2+ HANDS FREE Mk5 UTG body only	050-2015/5
Cygnus 4 GENERAL PURPOSE Mk5 UTG body only	050-4011/5
Cygnus 4+ GENERAL PURPOSE Mk5 UTG body only	050-4015/5
Cygnus 6+ PRO Mk5 UTG body only	050-6011/5
Cygnus 1 INTRINSICALLY SAFE CSA UTG Body only	001-7171-CSA/3
Cygnus 1 INTRINSICALLY SAFE ATEX UTG Body only	001-7171-ATEX/3
Cygnus DIVE UTG Mk2 Body only	001-7255/2
Cygnus DIVE Data Logging Mk2 UTG Body only	001-7259/2
Cygnus UNDERWATER Gauge Body only with Topside Connector	001-7179/4
Topside Repeater (Repeater Body only)	001-7181/4
Topside Repeater with Video OSD (Repeater Body only)	001-7182/4
Cygnus HEAVY DUTY UTG Body only	001-7170/4
Cygnus ROV Mountable 2000m UTG Body only	001-7189/5
Cygnus ROV Mountable 4000m UTG Body only	001-7191/5
Cygnus MINI ROV Mountable UTG Body only	001-7190/4



Spares for previous models

Probe Leads for Cygnus 2, 3 & 4 Mk 2/3

Order Code

Probe Lead RG58 Lemo 00 to BNC (1.35m 4'6")	001-0402
Probe Lead RG58 Lemo 00 to Lemo 00 (1.35m 4'6")	001-0400
Probe Lead RG58 BNC to BNC (length 1.35m 4'6")	002-0404
Probe Lead RG58 (+ Choke) Lemo 00 to Lemo 00 (1.35m 4'6")	001-0436

(For use with Cygnus SE Gauge only)

Probes for Cygnus Intrinsically Safe Mk 1/2 up to S/N 3231

Probe S2C 2.25MHz 13mm (1/2") for Cygnus 1 IS (Mk1/2)	001-9325
Probe S2C 2.25MHz 19mm (3/4") for Cygnus 1 IS (Mk1/2)	001-9324
Probe S3C 3.5MHz 13mm (1/2") for Cygnus 1 IS (Mk1/2) UTG	001-9326
Probe S5A 5MHz 6mm (1/4") for Cygnus 1 IS (Mk1/2)	001-9329
Probe S5C 5MHz 13mm (1/2") for Cygnus 1 IS (Mk1/2)	001-9327
Right Angle Probe S2C 2.25MHz 13mm (1/2") for Cygnus 1IS Mk1/2	001-9372
Right Angle Probe S3C 3.5MHz 13mm 1/2" for Cygnus 1 IS Mk1/2	001-9374
Right Angle Probe S5A 5MHz 6mm (1/4") for Cygnus 1 IS Mk1/2	001-9375
Right Angle Probe S5C 5MHz 13mm (1/2") for Cygnus 1 IS Mk1/2	001-9376

Probes for Cygnus ROV Gauges up to Mk4 S/N 496

Probe S2C 2.25MHz 13mm for Cygnus ROV 1km/3km UTG (5m cable)	003-9393
Probe S2D 2.25MHz 19mm (3/4") for Cygnus ROV 1km/3km UTG	003-9395
Probe S2C 2.25MHz 13mm (1/2") with Nosecone for W1 (5m cable)	001-8317

Battery & Chargers for Cygnus UW / Intrinsically Safe Mk 1/2 up to S/N 3231

Battery for Cygnus UNDERWATER UTG Mk1/2 (Uncharged)	001-1519
Battery Charger (UK) for Cygnus UW / IS Batteries Mk1/2	001-1520
Battery Charger (US) for Cygnus UW / IS Batteries Mk1/2	001-1521
Battery Charger (EU) for Cygnus UW / IS Batteries Mk1/2	001-1522

Cases & fixings

Soft Carry case & foam for Cygnus 2 / 3 / 4 Mk4 UTG	002-4838
Silicone Sleeve for Cygnus 2 HANDS FREE Mk4 Gauge	002-4835
Silicone Sleeve for Cygnus 4 GENERAL PURPOSE Mk4 or TSR	004-4835
Belt Clip for Silicone Sleeve for Cygnus 2 / 3 / 4 Mk4 UTG	002-4836/4
Neck strap for use with Cygnus 2 / 3 / 4 Mk4 UTG	002-4841
Leather Case for Cygnus 2 / 3 Mk3 UTG	002-4817
Leather Case for Cygnus 4 Mk 3	004-4804
Carry Case for Cygnus 4 Mk3/SE	004-4823



Cygnus FMD

Ultrasonic Flooded Member Detector

The FMD system comprises of three fundamental parts; the probe and probe handler, the subsea electronics unit and the reporting software. The innovative probe handling self aligns, ensuring correct contact with the member, even when approached from an angle. The probe contact sensor will not allow a test to be taken unless the probe is correctly aligned. The tough, rugged system returns a simple DRY / FLOODED result to the reporting software with results logged at the surface.



Standard items

Order Code

FMD-M1 Probe / Software / Peli case

110-0320

STS Option

Peli case containing:

110-0341

CRE Option

Probe 0.5MHz with cable and connector P/N 110-0201(STS) or 110-0233(CRE)

Software & manual on USB flash drive P/N 110-0316

Electronics, select from:

FMD-M1 Subsea Electronics Module CRE - Stainless Steel

110-0230

CRE Option



FMD-M1 Subsea Electronics Module CRE - Acetal

110-0231

CRE Option



Probe Holder, select from:

FMD-M1 Probe Handler - Acetal

110-0050

Both STS & CRE



FMD-M1 Probe Handler - Stainless Steel

110-0051



Probe Holder Handles, select from:

3/4" T-Bar Manipulator Handle

001-8314

Both STS & CRE



1/2" T-Bar Manipulator Handle

001-8315

Both STS & CRE

Fishtail Manipulator Handle

001-8316

Both STS & CRE



FMD component sets, select from:

FMD-M1 set of ROV components

110-0321

Both STS & CRE

consisting of:

RS232 to USB Serial interface cable P/N 110-0324

Patch cable 0.6m P/N 001-0451

Dual Test Lead RS485 & RS232 to 2 x 9WD M1-FMD P/N 110-0323

FMD-M1 set of diver components

110-0322

Both STS & CRE

consisting of:

D-Handle for Probe Handler - Stainless Steel P/N 110-0251

Surface PSU & comms connection unit P/N 110-0205

USB 2.0 Cable Male USB A to Male USB B 1.8m P/N 110-0303

3m test cable P/N 110-0315



Cygnus FMD

Ultrasonic Flooded Member Detector

Electronics Support Cage

	Order Code	
FMD-M1 Electronics Module Cable Support Cage	110-0213	STS Option
M1 FMD Electronics Module Cable Support Cage (Long for CRE)	110-0216	CRE Option

Test Piece, select from:

FMD-M1 System Test Piece	110-0204
--------------------------	----------



FMD-M1 System Test Piece (DRAWING ONLY)	110-0206	(non-discountable)
---	----------	--------------------

Umbilical cable, if required select from:

FMD-M1 120m Umbilical Cable and Reel	110-0211	(non-discountable)
--------------------------------------	----------	--------------------

FMD-M1 350m + 50m Umbilical Cable and Reel	110-0212	(non-discountable)
--	----------	--------------------



SPARES:

FMD-M1 Probe 0.5MHz, 5m Cable and Connector	110-0201	STS Option
FMD-M1 Probe 0.5MHz, 5m Cable and CRE Connector	110-0233	CRE Option
FMD-M1 Probe 0.5MHz, 2m Cable and Connector	110-0202	STS Option
FMD-M1 Probe 0.5MHz, 2.5m Cable and CRE Connector	110-0232	CRE Option



FMD-M1 Surface PSU and Comms Connection Unit	110-0205
--	----------



FMD-M1 Software and Manual on USB Flash Drive	110-0316	(non-discountable)
---	----------	--------------------



FMD-M1 Pelican Transit Case	110-0304	(non-discountable)
-----------------------------	----------	--------------------



FMD-M1 USB 2.0 Cable Male USB A to Male USB B 1.8m	110-0303
FMD-M1 RS232 to USB cable assembly 1m	110-0324
Patch cable 0.6m for FMD & 2000M/4000M ROV UTG	001-0451
FMD-M1 3m test cable	110-0315
FMD-M1 Dual Test Lead RS485 & RS232 to 2 x 9WD	110-0323
Isolated Data Converter (RS422/RS485 to USB)	001-8305
FMD-M1 Subconn Micro Circular Adaptor	110-0302
FMD-M1 SPARES - Subsea Electronics Module O-ring kit (S/S)	110-0317
FMD-M1 SPARES - Subsea Electronics Module O-ring kit (acetal)	110-0318
FMD-M1 Probe Knurled Ring Nut (S/S)	110-0300
FMD-M1 Probe Handler Probe Body Spring	110-0301



Cygnus HATCH SURE

Ultrasonic Hatch Leak Detector

The Cygnus Hatch Sure is a lightweight ultrasonic system for checking the weather-tightness of cargo hatch covers. The system consists of a battery powered transmitter which produces an omni-directional sound field, uniformly distributed throughout the cargo hold. The receiver part of the system displays the sound energy level that passes through gaps in the enclosed cargo hold to enable the location of leaks in the hatch seals to be quickly and accurately identified. The system weighs only 3.8 kg and is supplied in a shower-proof, rucksack-style carry case.

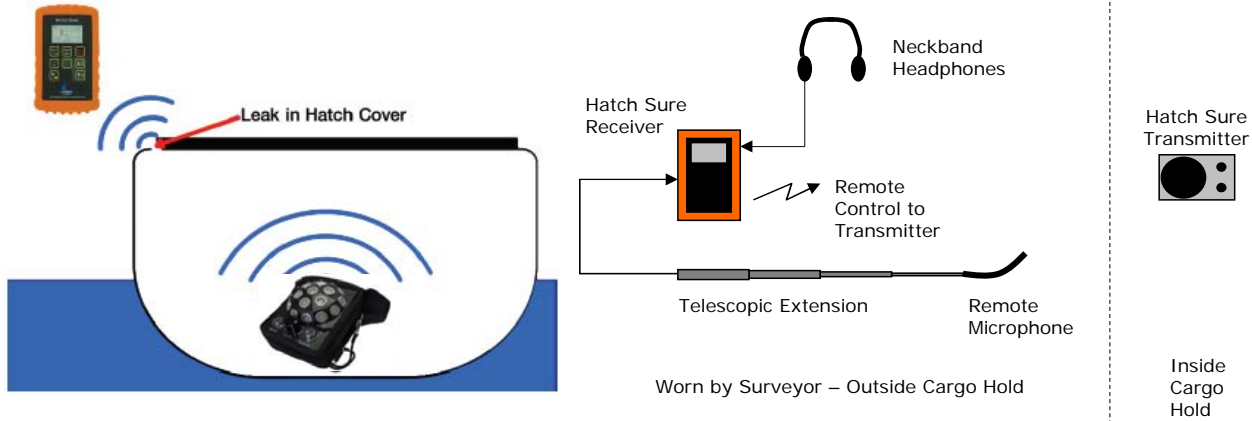

Cygnus HATCH SURE Kit

Order Code

Cygnus HATCH SURE Mk2 Hatch Cover Leak Detection System

006-1001

Contents: Ultrasonic receiver with protective case - neck & waist straps - 2 flexible inspection microphones - telescopic extension & cable for microphone - neck band headphones - variable output ultrasonic transmitter - with protective case & lowering harness - rechargeable batteries & charger - external 9 - 24 V DC power lead for transmitter - manual & carry case



General Spares for Cygnus HATCH SURE

Hatch Sure Mk2 Transmitter Unit	006-1010
Cygnus Hatch Sure Mk2 Receiver	006-1012
Inspection Microphone (235 x 10mm) for Hatch Sure Mk2	006-1020
Foam Cover for Cygnus Hatch Sure Mk2 Inspection Microphone	006-1018
Emergency Microphone Cable for Hatch Sure Mk2 Receiver	006-1016
Telescopic Extension for Hatch Sure Mk2	006-1003
Tripod for use with Hatch Sure Mk2	006-1056
Tripod bracket with Velcro for Hatch Sure Mk2 Transmitter	006-1054
BNC Straight Adapter for Cygnus Hatch Sure Mk2 Receiver	006-1017
Neckband Headphones for Hatch Sure Mk2	006-1004
Batteries 6 x AA NiMH MaxE for Hatch Sure Mk2 Transmitter	006-1005
<i>(Non discountable item)</i>	
Battery PP3 NiMH Max-e x 2 for Hatch Sure Mk2 Receiver	006-1006
<i>(Non discountable item)</i>	
Battery Charger KH980 for Hatch Sure Mk2 Kit	006-1007
DC Power Lead for Hatch Sure Mk2 Transmitter	006-1008
Orange Protective Boot for Hatch Sure Mk2 Receiver	006-1013



Inspection microphone



Telescopic extension for microphone



Ultrasonic Thickness Gauge Serial Numbers

Cygnus 2 HANDS FREE

Mk1 produced up to serial no. 1309
Mk2 produced up to serial no. 2146
Mk3 produced from serial no. 2147 (Lemo 00 connector in gauge)
Mk4 produced from serial no. 4000 (Lemo 1 connector in gauge)
Mk5 produced from serial no. 20001 (C2 Lemo 1 connector in gauge & C2+ Twin Lemo 00 connector in gauge)
(There is some overlap between Mk1 and Mk2 and may need to be checked)

Cygnus 3 DATA LOGGER

Mk1 produced up to serial no. 0512
Mk2 produced up to serial no. 0862
Mk3 produced from serial no. 0863 - 0959; 0100 - 0402 (Lemo 00 connector in gauge)
Mk4 produced from serial no. 4000 (Lemo 1 connector in gauge)
(There is some overlap between Mk1 and Mk2 and may need to be checked)

Cygnus 4 GENERAL PURPOSE

Mk2 produced up to serial no. 0333
Mk3 produced from serial no. 0334 (Lemo 00 connector in gauge)
Mk4 produced from serial no. 4000 (Lemo 1 connector in gauge)
Mk5 produced from serial no. 20001 (C4 Lemo 1 connector in gauge & C4+ Twin Lemo 00 connector in gauge)

Cygnus 6+ PRO

Mk5 produced from 20001 (C6+ Twin Lemo 00 connector in gauge)

Cygnus 1 INTRINSICALLY SAFE

Mk1 produced up to serial no. 2125
Mk2 produced from serial no. 2170
Mk3 produced from serial no. 3232
(Serial nos. 2126 - 2169 may be either Mk1 or Mk 2 and will need to be checked)

Cygnus HEAVY DUTY

Mk1 produced up to serial no. 2125
Mk2 produced from serial no. 2170
Mk3 produced from serial no. 3232
Mk4 produced from serial no. 4985
(Serial nos. 2126 - 2169 may be either Mk1 or Mk 2 and will need to be checked)

Cygnus DIVE

Mk1 produced up to serial no. 10421
Mk2 produced from serial no. 11001

Cygnus UNDERWATER

Mk1 produced up to serial no. 2125
Mk2 produced from serial no. 2170
Mk3 produced from serial no. 3232
Mk4 produced from serial no. 4985
(Serial nos. 2126 - 2169 may be either Mk1 or Mk 2 and will need to be checked)

Cygnus ROV MOUNTABLE

Mk2 produced from serial no. 1
Mk3 produced from serial no. 50
Mk4 produced from serial no. 148
Mk5 produced from serial no. 500

Cygnus FMD

Mk1 produced from serial no. 40016

